

Talbot Wood Products Ltd

CABINET DOOR CATALOG



Talbot Wood Products Ltd

5585 Hwy. 3, P.O. Box 190, Cayuga, Ontario N0A 1E0. Tel:(905)772-0007 Fax: (905)772-6363 E-mail:info@talbotwood.com

DOOR TYPES

S = RAISED PANEL DOOR
P = FLAT PANEL DOOR
(MIN 9IN WIDE FOR ARCH DOORS)

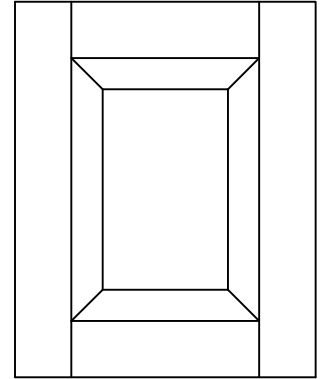

S100

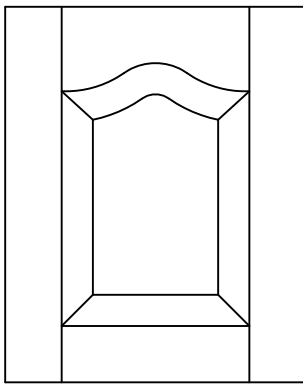

S200

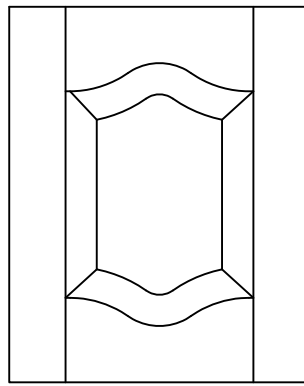

S300

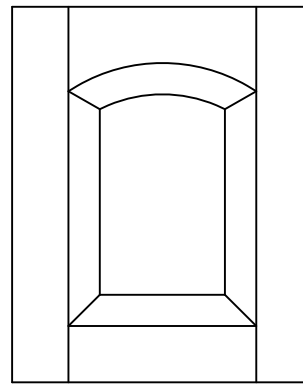

S400

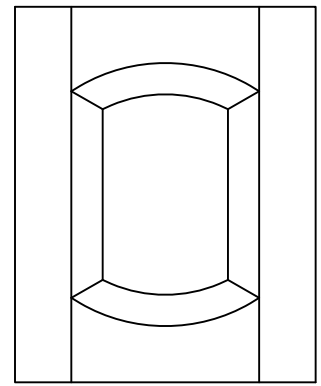

S500

FLAT PANEL DOOR
(MIN 9IN WIDE FOR ARCH DOORS)

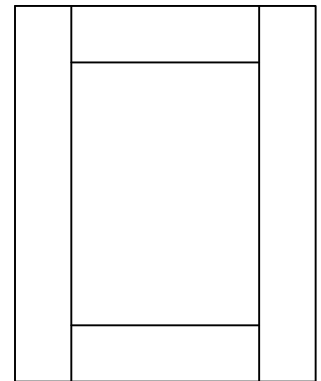

P100

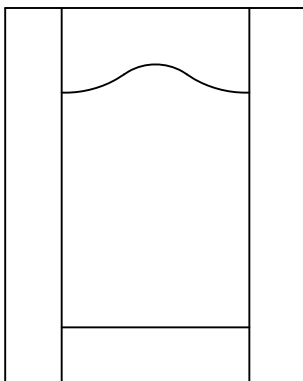

P200

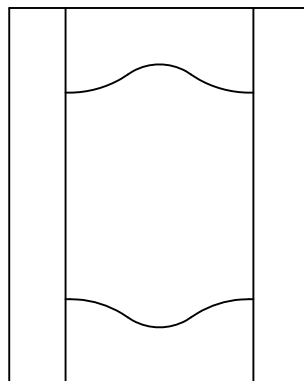

P300

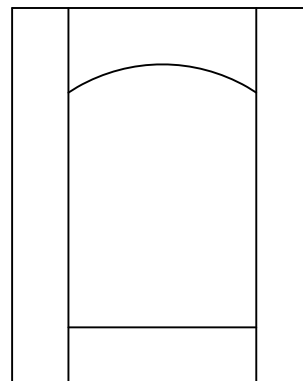

P400

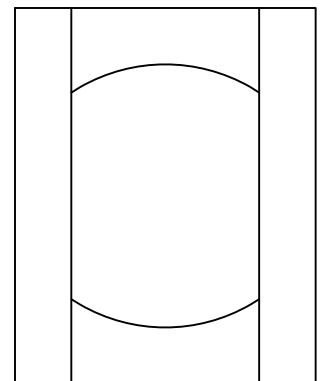

P500

Talbot Wood Products Ltd

5585 Hwy. 3, P.O. Box 190, Cayuga, Ontario N0A 1E0. Tel:(905)772-0007 Fax: (905)772-6363 E-mail:info@talbotwood.com

DRAWER TYPES

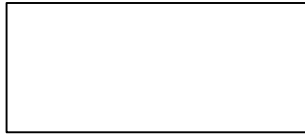

SLAB

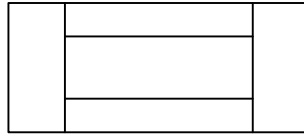

P100

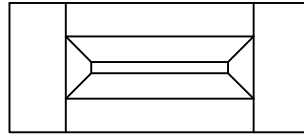

S100

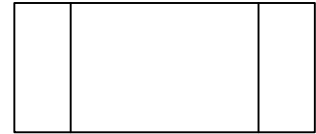

SL3

	DEPTH OF CUTTER	PANEL MIN.	TOP AND BOTTOM REDUCED	2" STILES	STANDARD 2 1/4" STILES	3" STILES
A	1 1/4 in	3 1/4 in	5 3/4 in	7 1/4 in	7 3/4 in	9 1/4 in
B	1 3/8 in	3 1/2 in	6 in	7 1/2 in	8 in	9 1/2 in
C	1 1/2 in	3 3/4 in	6 1/4 in	7 3/4 in	8 1/4 in	9 3/4 in
D	1 1/4 in	3 1/4 in	5 3/4 in	7 1/4 in	7 3/4 in	9 1/4 in
F	1 3/4 in	4 1/4 in	6 3/4 in	8 1/4 in	8 3/4 in	10 1/4 in
H	1 1/2 in	3 3/4 in	6 1/4 in	7 3/4 in	8 1/4 in	9 3/4 in
J	1 3/16 in	3 1/8 in	5 5/8 in	7 1/8 in	7 5/8 in	9 1/8 in
L	1 11/16 in	4 1/8 in	6 5/8 in	8 1/8 in	8 5/8 in	10 1/8 in

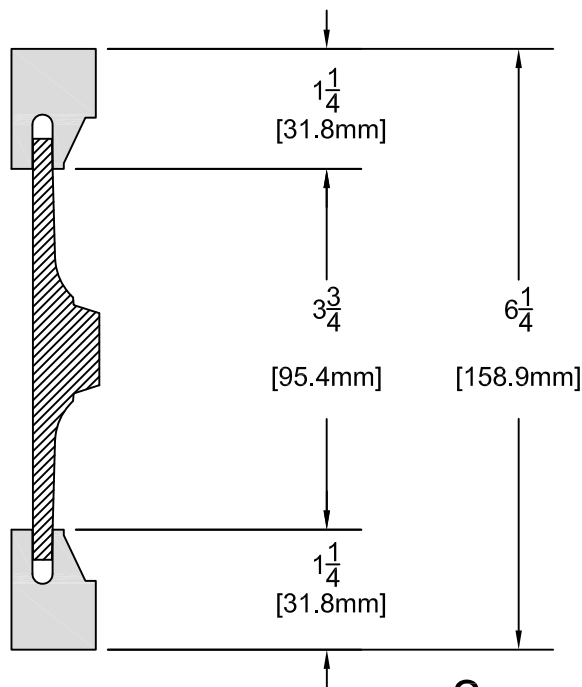

DOOR RAIL AND STYLES



51
 $2\frac{1}{4}$ [58mm]

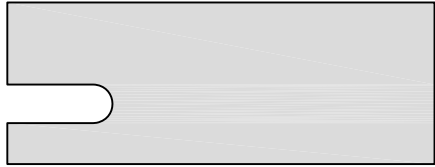

52
 $2\frac{1}{4}$ [57mm]



53
 $2\frac{1}{4}$ [56mm]



54
 $2\frac{1}{4}$ [57mm]



55
 $2\frac{1}{4}$ [58mm]



59
 $2\frac{1}{4}$ [57mm]



62
 $2\frac{1}{4}$ [56mm]

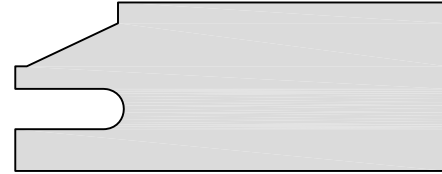

63
 $2\frac{1}{4}$ [57mm]



66
 $2\frac{1}{4}$ [58mm]



67
 $2\frac{1}{4}$ [58mm]



71
 $2\frac{1}{4}$ [58mm]



72
 $2\frac{1}{4}$ [57mm]

Talbot Wood Products Ltd

5585 Hwy. 3, P.O. Box 190, Cayuga, Ontario N0A 1E0. Tel:(905)772-0007 Fax: (905)772-6363 E-mail:info@talbotwood.com

MITERED DOOR RAIL

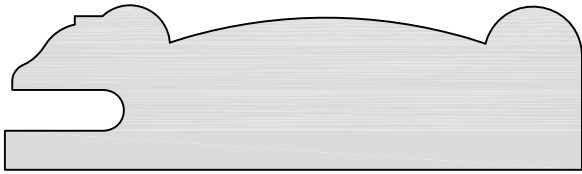

MD1 3 [76mm]

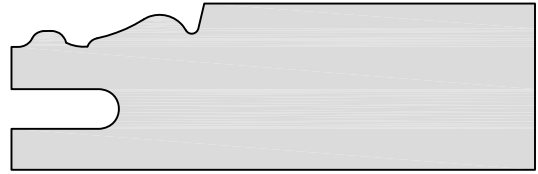

MD4 $2\frac{3}{4}$ [69mm]

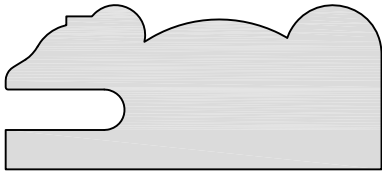

MD1(2) $1\frac{15}{16}$ [50mm]



MD8 $3\frac{5}{16}$ [84mm]

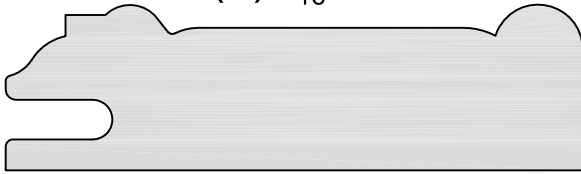

MD1A 3 [76mm]

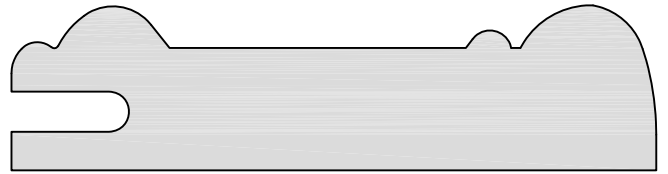

MD10 $3\frac{3}{8}$ [85mm]

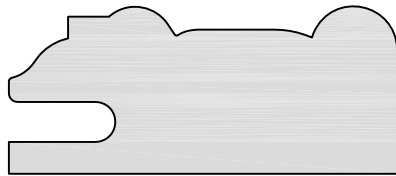

MD1A(2) 2 [51mm]

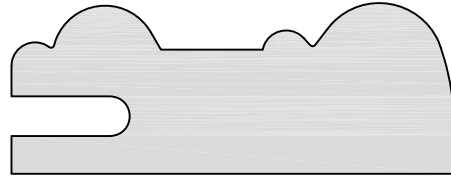

MD10 (2) $2\frac{5}{16}$ [59mm]



MD2 $2\frac{3}{8}$ [60mm]

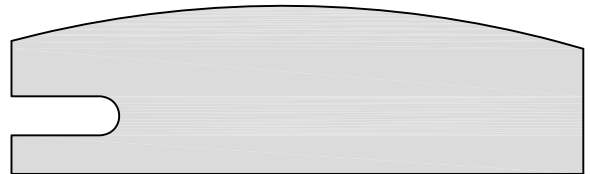

MD11 3 [76mm]

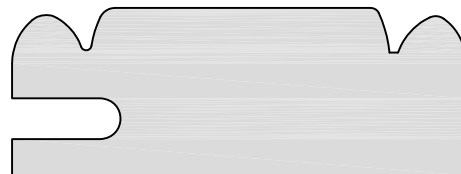

MD3 $2\frac{3}{8}$ [60mm]

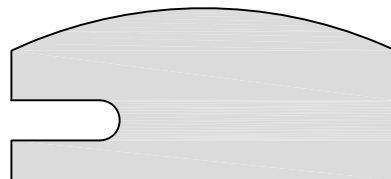

MD11(2) 2 [51mm]

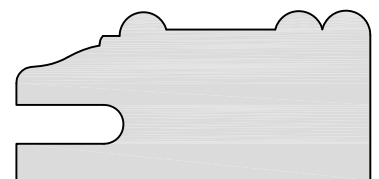

MD12(2) 2 [51mm]



MD12 $2\frac{7}{8}$ [73mm]



MD 14 $2\frac{3}{4}$ [70mm]

Talbot Wood Products Ltd

5585 Hwy. 3, P.O. Box 190, Cayuga, Ontario N0A 1E0. Tel:(905)772-0007 Fax: (905)772-6363 E-mail:info@talbotwood.com

PANEL STYLES

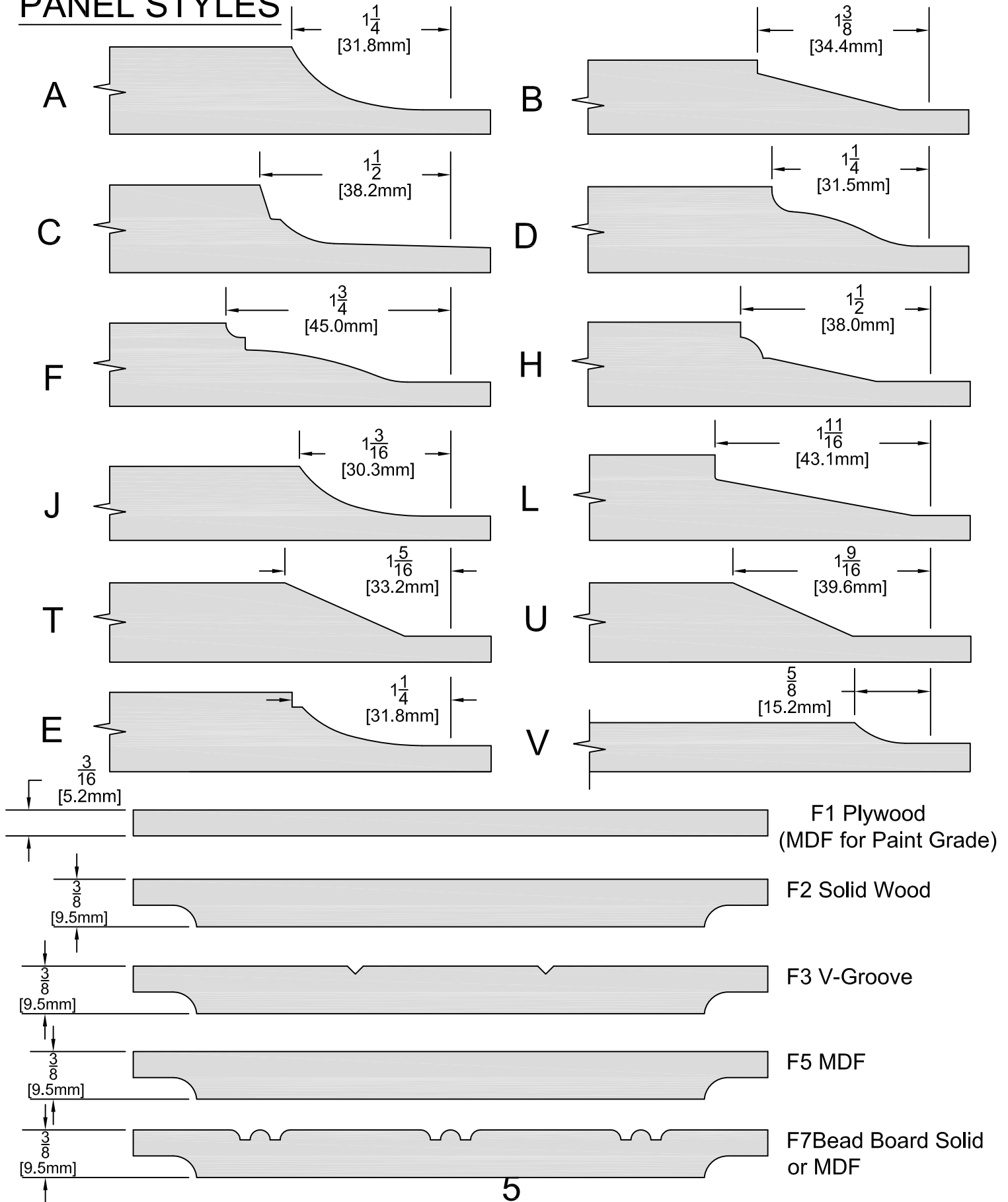

Talbot Wood Products Ltd

5585 Hwy. 3, P.O. Box 190, Cayuga, Ontario N0A 1E0. Tel:(905)772-0007 Fax: (905)772-6363 E-mail:info@talbotwood.com

WOOD DOOR EDGE PROFILES



W0

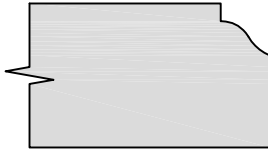

W3



W4



W5



W6



W7

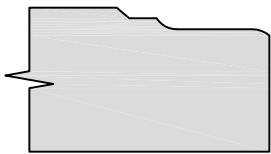

W10



W11

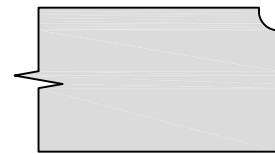

W12



W13



W14



W15

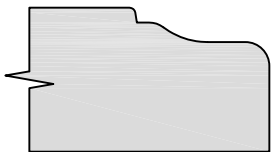

W16



W17

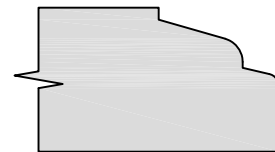

W18

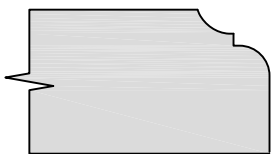

W19

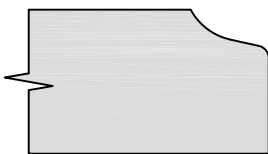

W20



W21



W22

Talbot Wood Products Ltd

5585 Hwy. 3, P.O. Box 190, Cayuga, Ontario N0A 1E0. Tel:(905)772-0007 Fax: (905)772-6363 E-mail:info@talbotwood.com

MDF DOOR VARIATIONS



SLAB

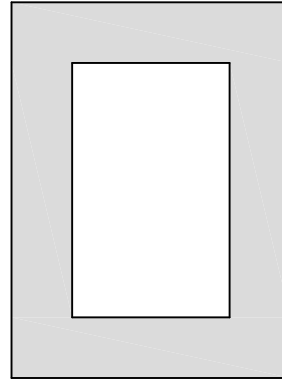

SHAKER

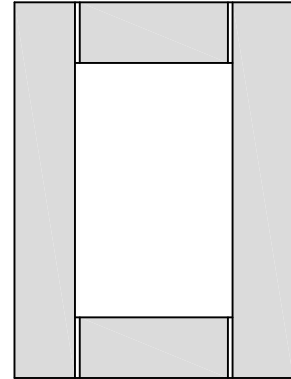

Faux 5 Piece

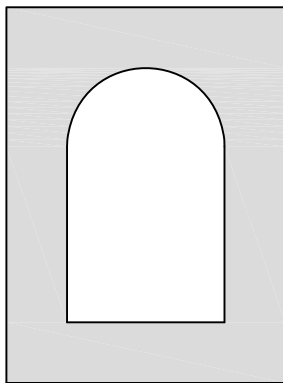

CIRCLE

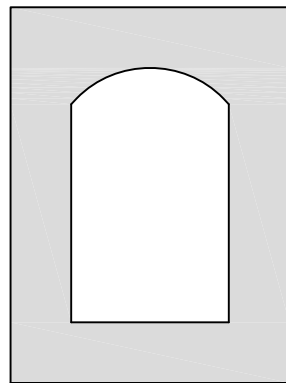

ROMAN

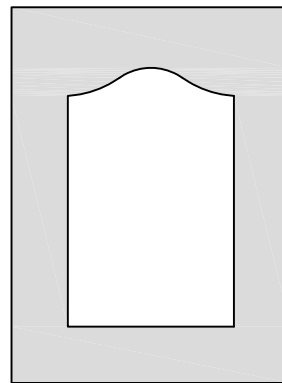

CATHEDRAL

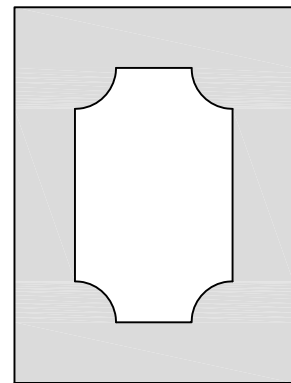

IN-CORNER

MDF DRAWER VARIATIONS

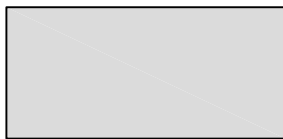

SLAB

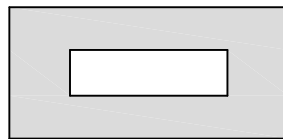

SHAKER

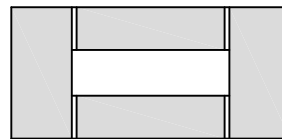

Faux 5 Piece

Talbot Wood Products Ltd

5585 Hwy. 3, P.O. Box 190, Cayuga, Ontario N0A 1E0. Tel:(905)772-0007 Fax: (905)772-6363 E-mail:info@talbotwood.com

MDF SHAKER SERIES



Shaker Step

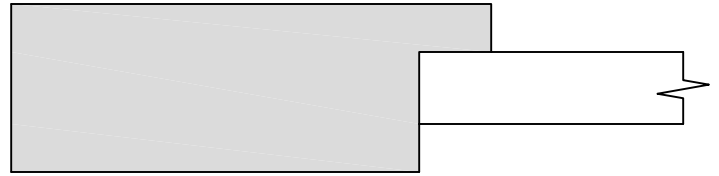

Shaker Insert

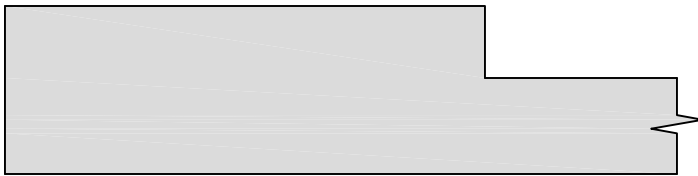

Shaker

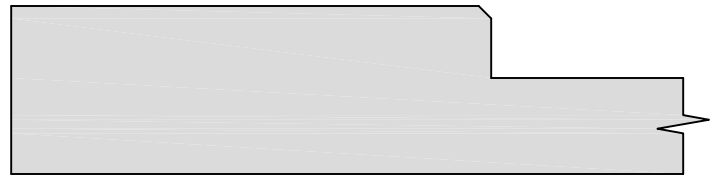

Shaker Bevel

MDF STANDARD SERIES



Colonial

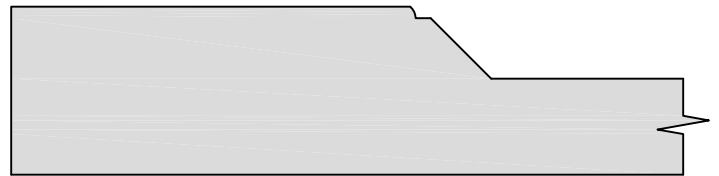

Classic



Contemporary



Traditional



Bead

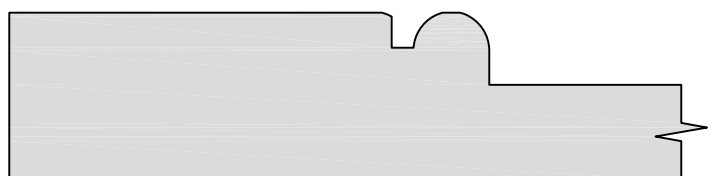

Large Bead

Talbot Wood Products Ltd

5585 Hwy. 3, P.O. Box 190, Cayuga, Ontario N0A 1E0. Tel:(905)772-0007 Fax: (905)772-6363 E-mail:info@talbotwood.com



Mission



Bertram

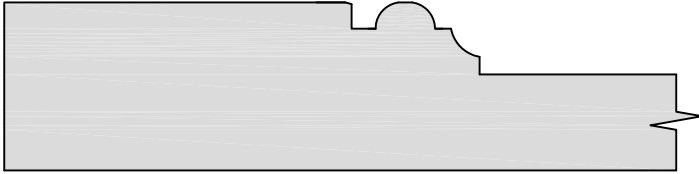

Rita

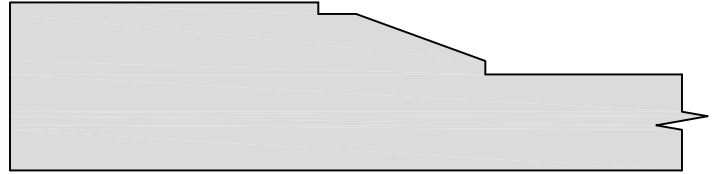

20 Deg

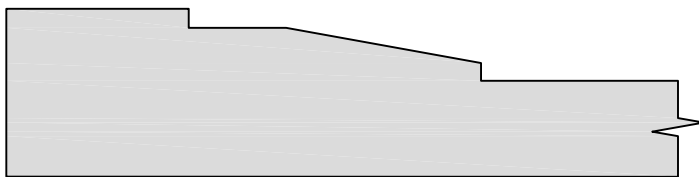

10 Deg



Regency



Ogee



Essex

MDF CUSTOM SERIES

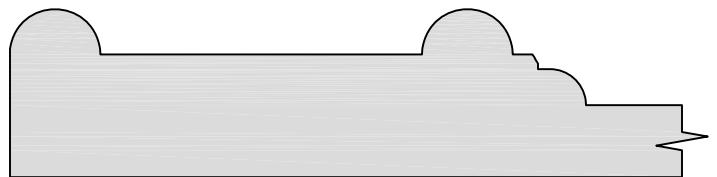

Legacy

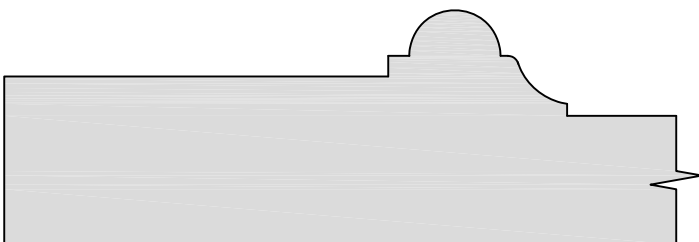

Jersey Raised

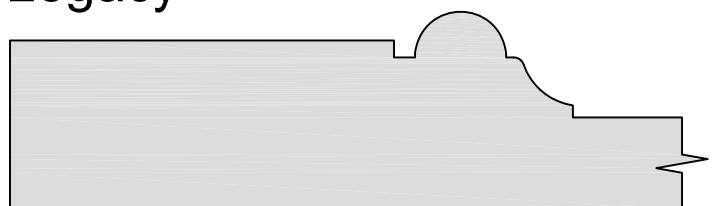

Jersey

Talbot Wood Products Ltd

5585 Hwy. 3, P.O. Box 190, Cayuga, Ontario N0A 1E0. Tel:(905)772-0007 Fax: (905)772-6363 E-mail:info@talbotwood.com

MDF PANELS



PF

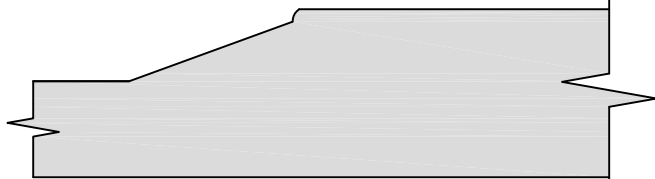

P1

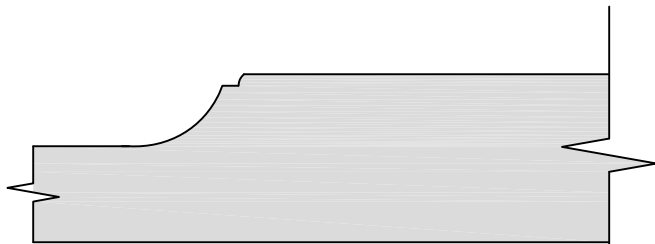

P2



P3



P4 (INSERT)

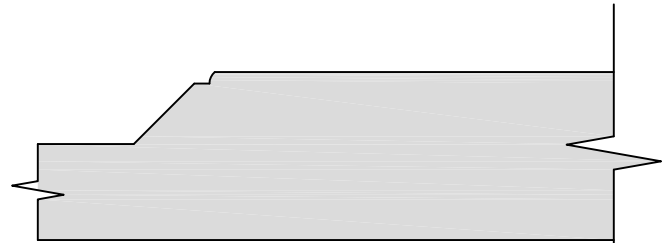

P5

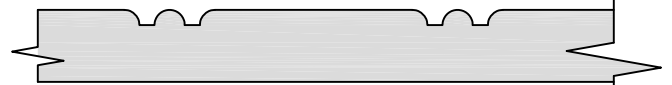

P6 (INSERT)



P7 ($\frac{3}{8}$ INSERT)



P8 ($\frac{1}{4}$ INSERT)

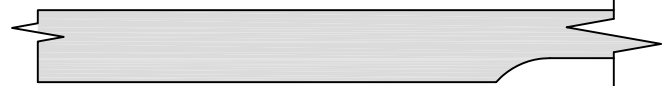

P9 ($\frac{3}{8}$ INSERT,
BACK RELIEF)

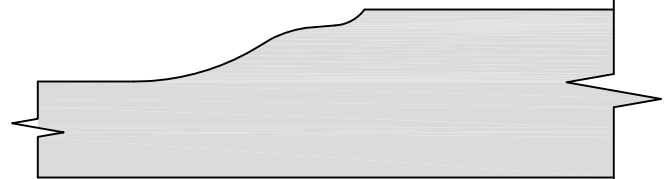

P10

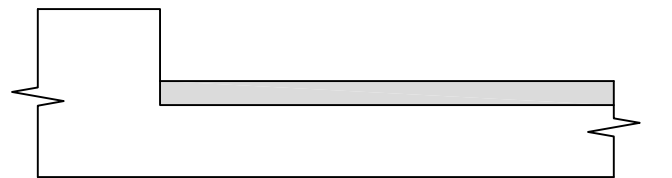

P11 (FRONT
INSERT)

Talbot Wood Products Ltd

5585 Hwy. 3, P.O. Box 190, Cayuga, Ontario N0A 1E0. Tel:(905)772-0007 Fax: (905)772-6363 E-mail:info@talbotwood.com

MDF EDGES DETAILS



M0



M1

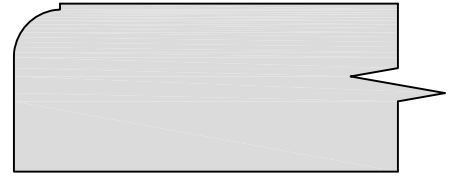

M2



M3



M4



M5

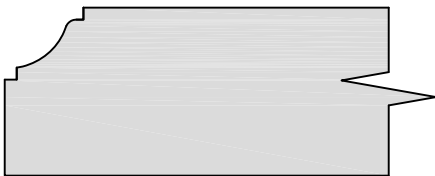

M6



M7



M8



M9

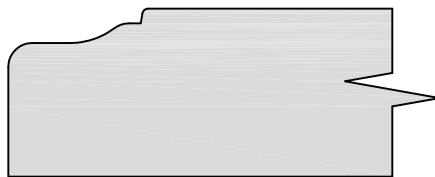

M10



M11



M12



M13



M14



M15



M16



M17

Talbot Wood Products Ltd

5585 Hwy. 3, P.O. Box 190, Cayuga, Ontario N0A 1E0. Tel:(905)772-0007 Fax: (905)772-6363 E-mail:info@talbotwood.com

LITES

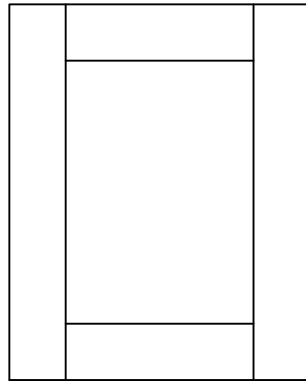

Frame Only

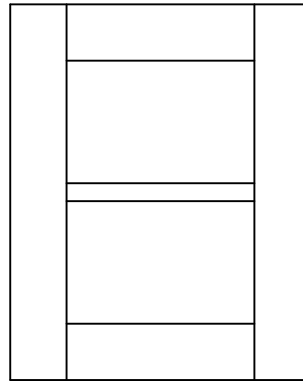

2H

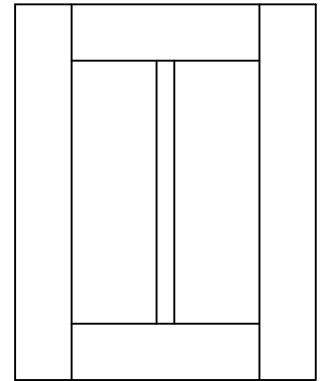

2V

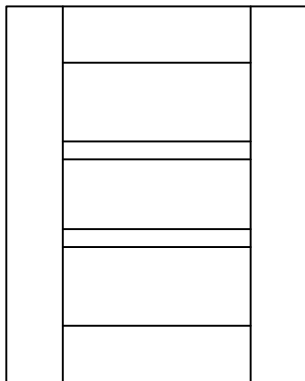

3

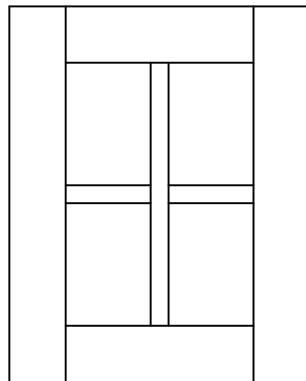

4

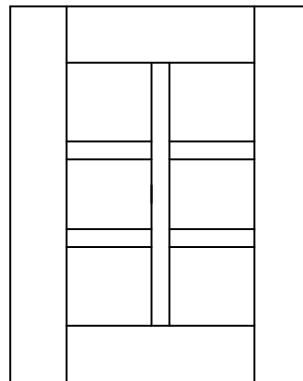

6

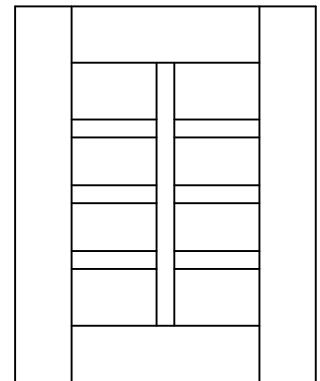

8

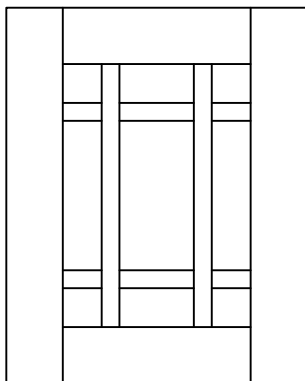

9

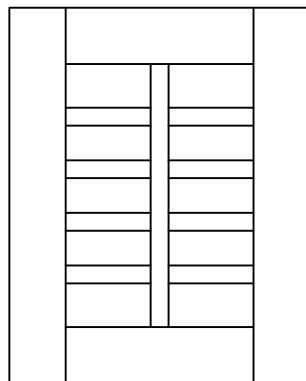

10

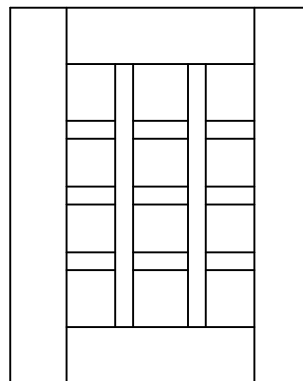

12

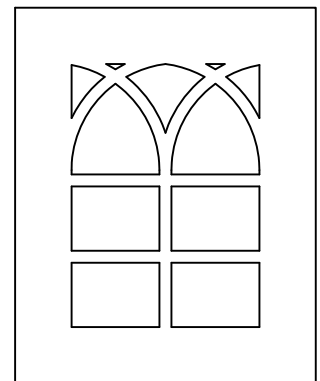

CUSTOM
CHURCH
MDF ONLY

APPLIED MOULDINGS

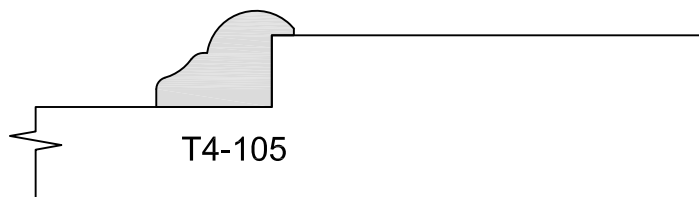
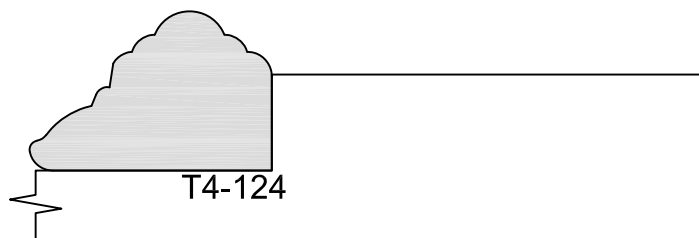
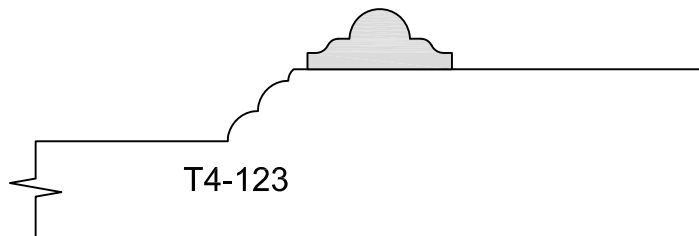
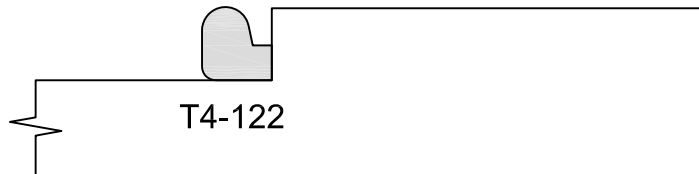
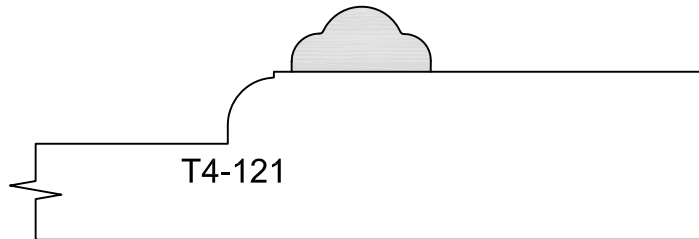
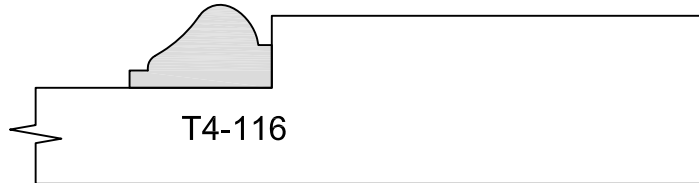
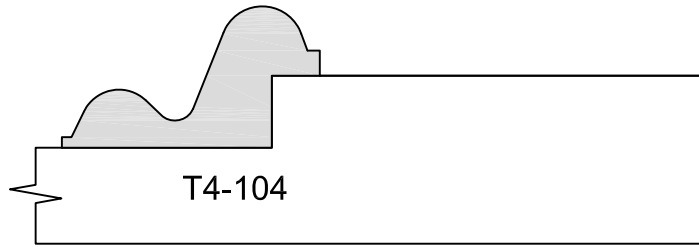

Talbot Wood Products

Tel: 905-772-0007 ~ Fax: 905-772-6363 ~ info@talbotwood.com

Date:	
TAG:	
Company Name:	Door Profile
Address:	Inside Frame Profile
	Centre Panel
City:	Postal Code:
Tel:	Fax: -
Grade and Wood Species:	Applied Moulding

Doors

No.	Qty	Width	Height
1			
2			
3			
4			
5			
6			
7			
8			
9			
10			
11			
12			
13			
14			
15			
16			
17			
18			
19			
20			
21			
22			
23			
24			
25			
26			
27			
28			
29			
30			

Drawers

No.	Qty	Width	Height	Rail Height
1				
2				
3				
4				
5				
6				
7				
8				
9				
10				
11				
12				
13				
14				
15				
16				
17				
18				
19				
20				

Glass Doors

No.	Qty	Width	Height	Lites
1				
2				
3				
4				
5				
6				
7				
8				

Special Notes:

Total Doors: 0 Total Drawers: 0 Total Pieces: 0