

POCKET CATALOGUE

TWP

Ltd.
Talbot Wood Products



5585 Hwy 3 • PO Box 190
Cayuga, ON N0A 1E0
talbotwood.com



INDEX

Wood Species	2
Our Products.....	3
Casings	4
Light Valance & Sills	7
Backbands & Caps.....	8
Casing Backband Combinations	10
Curved Mouldings.....	12
Corner Blocks & Plinth	13
Baseboards	14
Crowns.....	19
Panel & Applied	23
Quarter Rounds, Burlap, Coves.....	25
Bedmoulds, Doorstops	26
Chair Rails	27
Bar Rails	28
Handrails	29
Spindles	31
Custom Posts & Caps.....	32
Stair Treads	32
Stair Components	33
Dressed Four Sides.....	34
Bevelled Jambs	35
Flooring	36
Ship Lap & Laminated Panels	37
Interior Doors.....	38
Sheet Stock Inventory	39

WOOD SPECIES

Standard Species

Poplar
Red Oak
Hard White Maple
Hard Brown Maple
Birch
Cherry
Knotty Pine
Clear Pine
Soft Maple
Rift Cut White Oak
Quarter Cut White Oak
Walnut
Hickory

*Rough sawn lumber available in 4/4 and 8/4.
Other thicknesses and sizes available upon request.*

Available Non-Stock Species

Cedar
Mahogany (Khaya and Genuine)
Jatoba (Brazilian Cherry)
European Steamed Beech
Wenge
Alder (Knotty and Clear)

Please call to inquire about other species.

OUR PRODUCTS

At Talbot Wood we value quality and service to our customers above all else. Our 44,000 square foot plant is vertically integrated to provide one of the most complete product mixes in the industry. We have hundreds of in stock profiles in a variety of species and many more in our custom profile department: rough lumber, dressed 4 sides, dimensioned product, custom cabinet doors, dovetail drawer boxes, CNC machining, and laminated products are all available with short lead times. If there is something you don't see in our catalogue please contact us as we have the ability to make custom profiles in house. We source our lumber from suppliers who comply with all government regulations working to provide material with the best yield possible. Additionally we recycle over 90% of our solid wood waste for resale instead of putting it directly into the landfill; this allows us to keep costs down while protecting the environment.



CASINGS

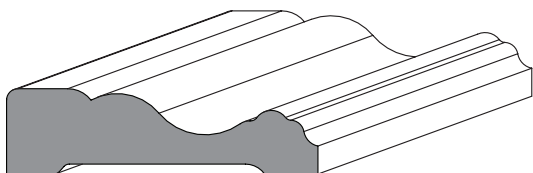

T1-101 3/4 x 2-3/4

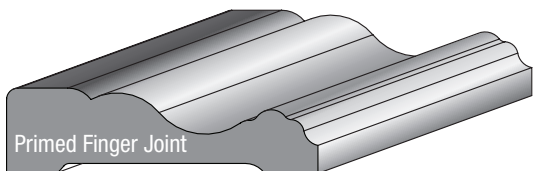

Primed Finger Joint

T1-162 3/4 x 2-3/4

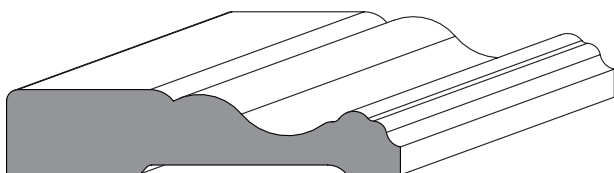

T1-102 3/4 x 3-1/2

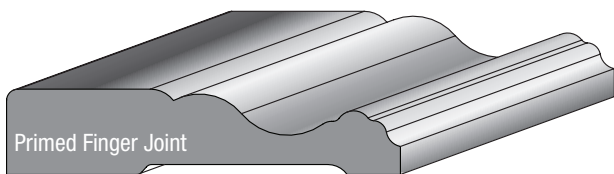

Primed Finger Joint

T1-163 3/4 x 3-1/2

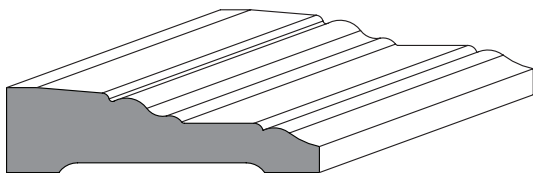

T1-111 3/4 x 2-3/4

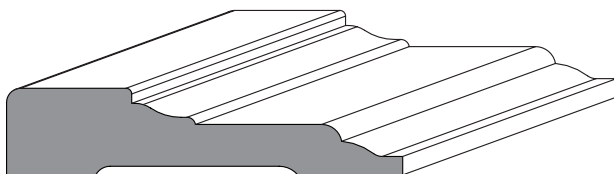

T1-113 3/4 x 3-1/2

CASINGS

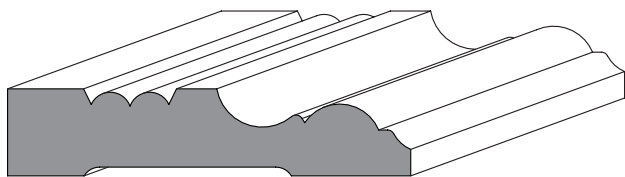

T1-121 3/4 x 3-1/2

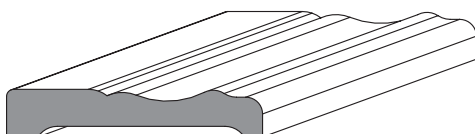

T1-151 7/16 x 2-1/4

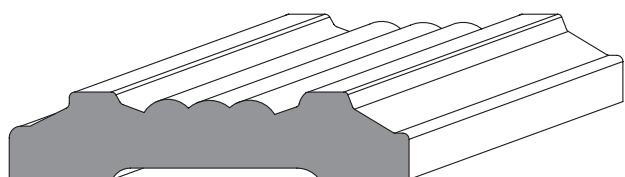

T1-161 3/4 x 3-1/2

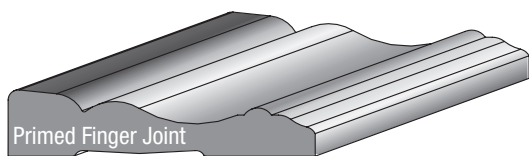

T1-141 5/8 x 2-3/4

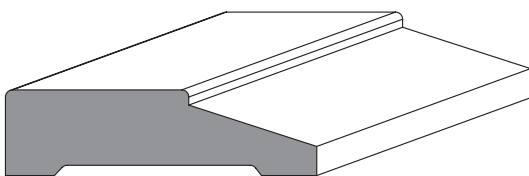

T1-131 3/4 x 2-3/4

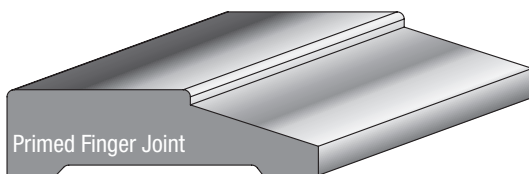

T1-164 3/4 x 2-3/4

CASINGS

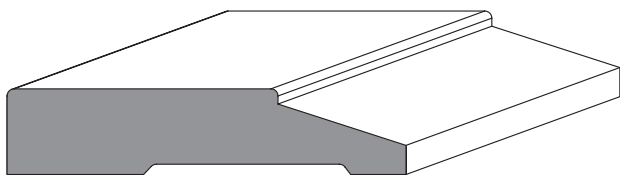

T1-132 3/4 x 3-1/2

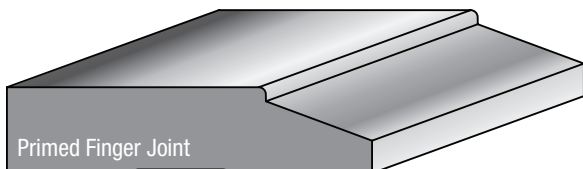

Primed Finger Joint

T1-165 3/4 x 3-1/4

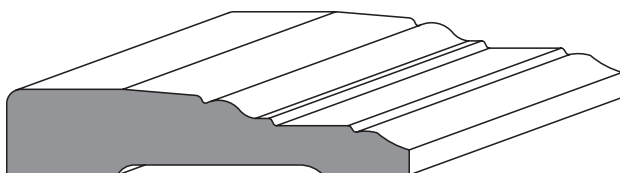

T1-133 3/4 x 3-1/2

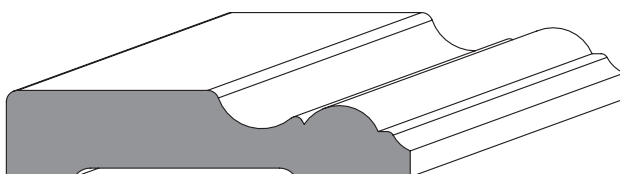

T1-134 3/4 x 3-1/2



T1-114 3/4 x 3-1/2

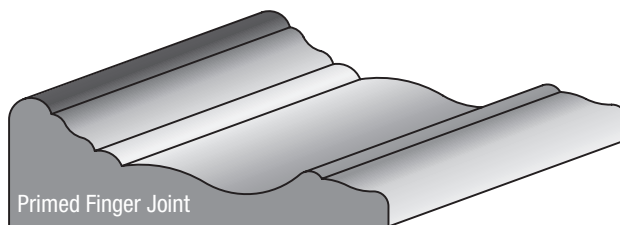

Primed Finger Joint

T1-143 1-1/16 x 3

LIGHT VALANCE & SILL

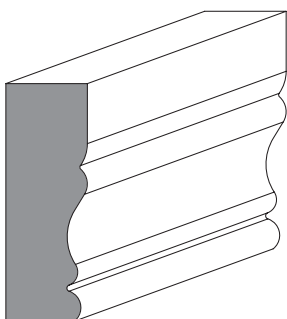

T1-504

3/4 x 2-1/4

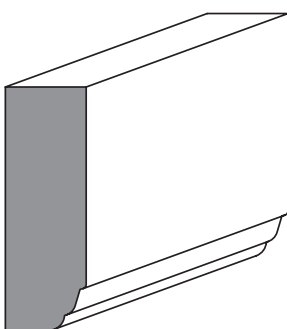

T1-502

3/4 x 2-1/4

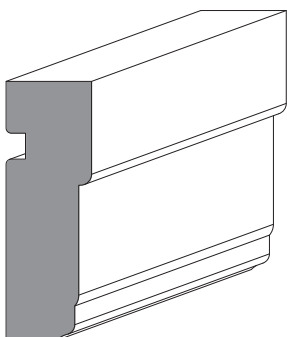

NEW! T1-506 Valance

13/16 x 2-1/2

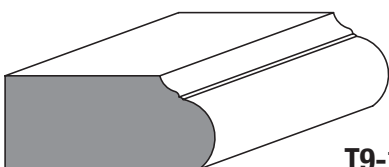

T9-119 1 x 2-1/4

CASINGS

LIGHT VALANCE & SILL

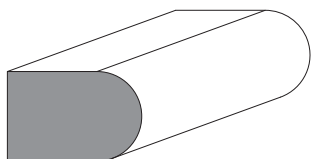

NEW! T5-309
1 x 1-1/2

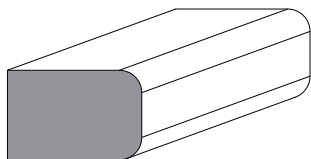

NEW! T5-308
1 x 1-1/2

BACKBANDS & CAPS

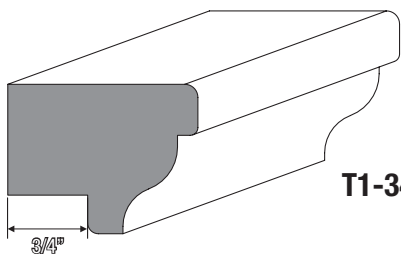

T1-341 1-3/4 x 1-3/8

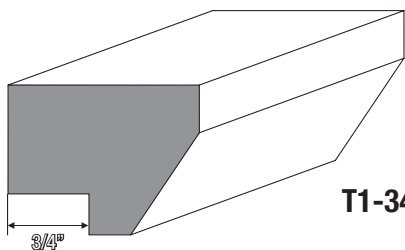

T1-342 1-3/4 x 1-3/8

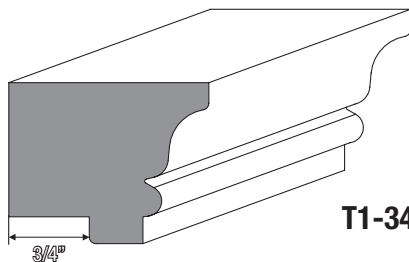

T1-343 1-3/4 x 1-11/16

BACKBANDS & CAPS

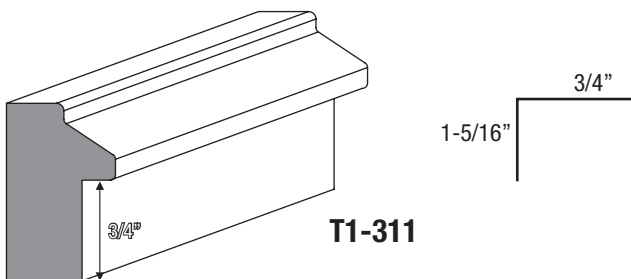
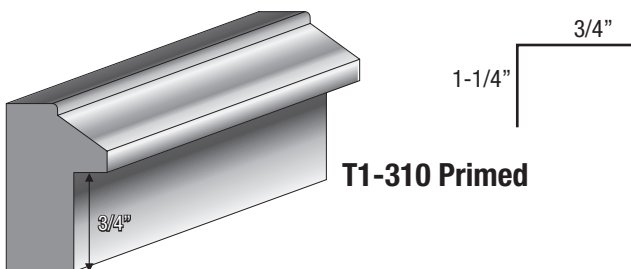
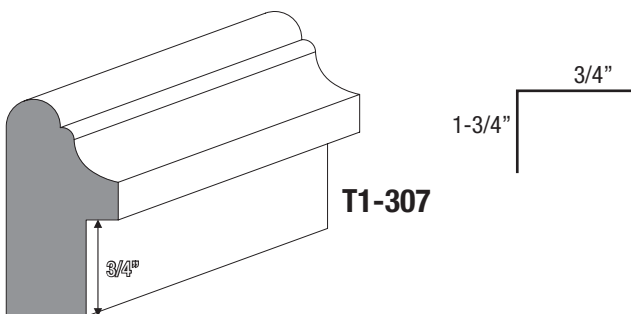
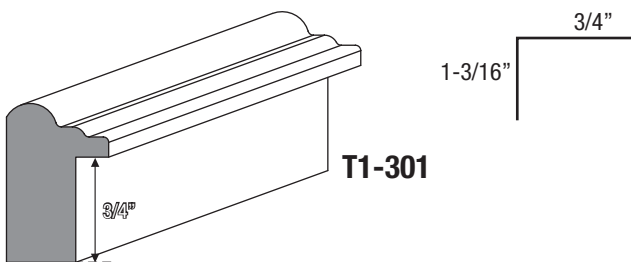

BACKBANDS & CAPS

BACKBANDS & CAPS

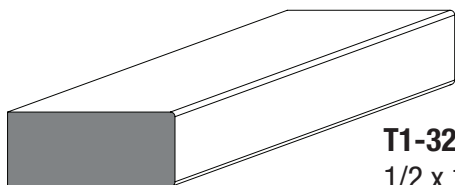

T1-320
1/2 x 1-1/2

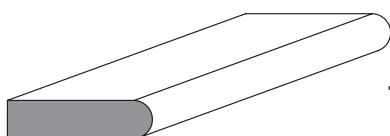

T9-117
5/16 x 1-1/8

CASING BACKBAND COMBINATIONS

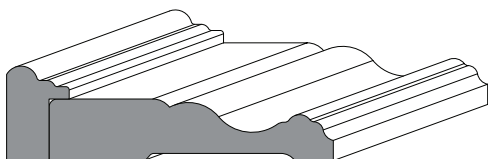

T1-301 with T1-102

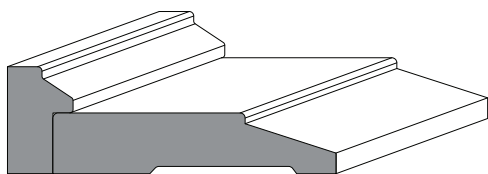

T1-311 with T1-132

BUILD-UPS AND ARCHITRAVES

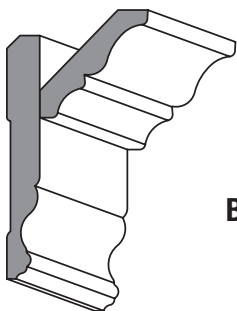

T3-102 with T2-102

Buildups

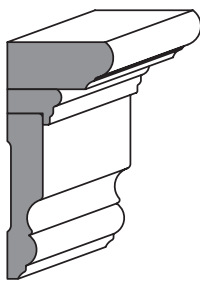

**T9-119 with T1-301
& T1-134**

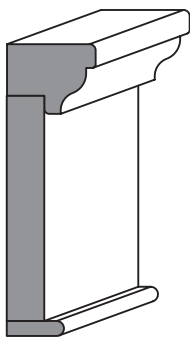

**T1-341 with 1x5 D4S
& T9-117**

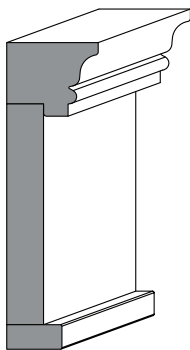

**T1-343 with 1x5 D4S
& T1-320**

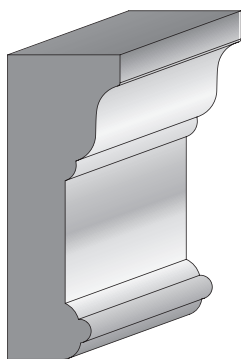

**T9-154 Primed
1-1/4 x 4-3/4**

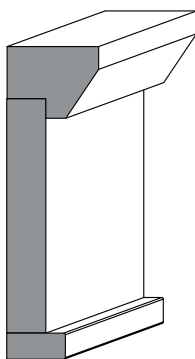

**T1-342 with 1x5 D4S
& T1-320**

CASING BACKBAND COMBINATIONS

CURVED MOULDINGS

Talbot Wood has full CNC capabilities to replicate most of our moulding profiles for curved applications. Templates need to be provided where curves are not symmetrical. Please allow 2 to 3 weeks for all custom curved mouldings.

ARCHED WINDOW TRIM AVAILABLE
IN MOST PROFILES. CUSTOM
AVAILABLE WITH SAMPLE TRIM.

TRUE CIRCLE

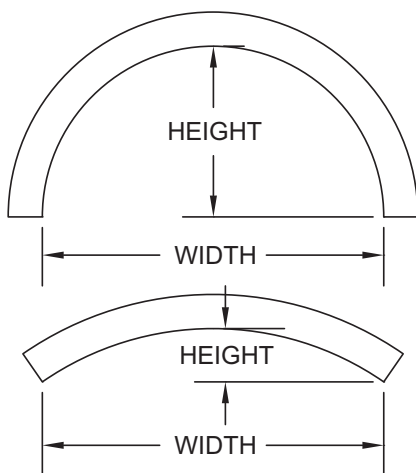

ELLIPTICAL TEMPLATE REQUIRED

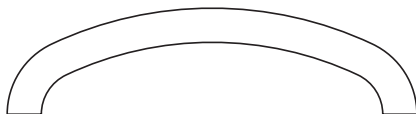

CORNER BLOCKS & PLINTH

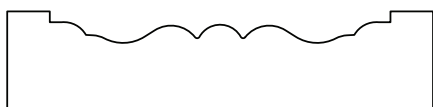
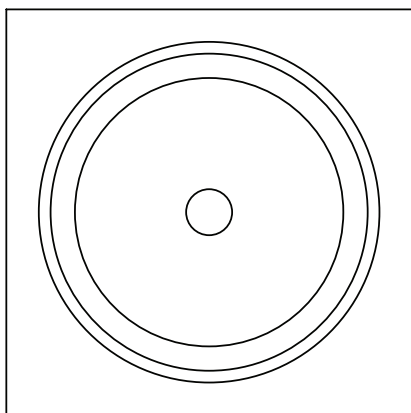

T9-159
7/8 x 3-3/4

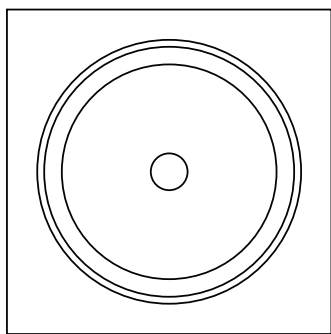
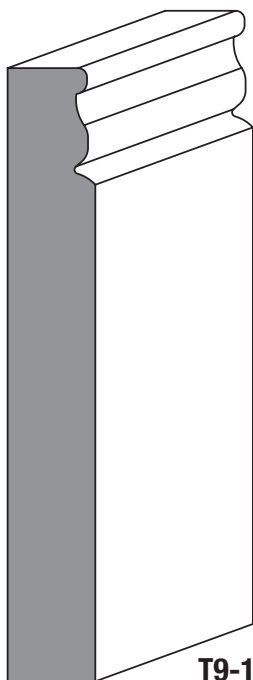

T9-158 7/8 x 3

T9-121 1 x 7-5/16

CORNER BLOCKS & PLINTH

BASEBOARDS

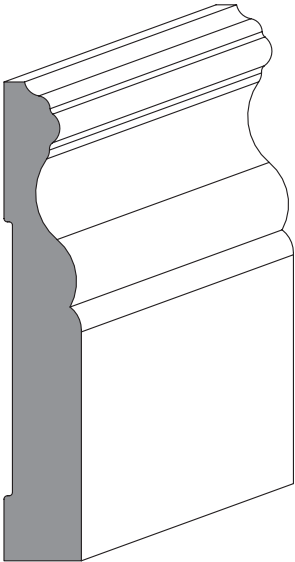

T2-101 11/16 x 4-1/4

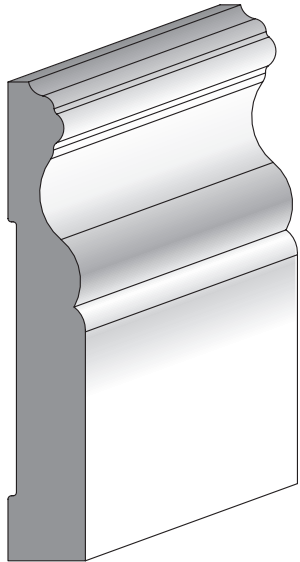

T2-201 5/8 x 4-1/4
Primed (**NEW**)

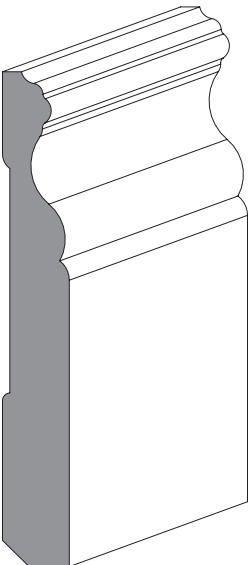

T2-102 11/16 x 5-1/4

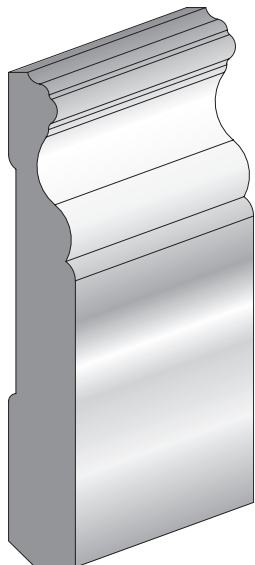

T2-202 5/8 x 5-1/4
Primed (**NEW**)

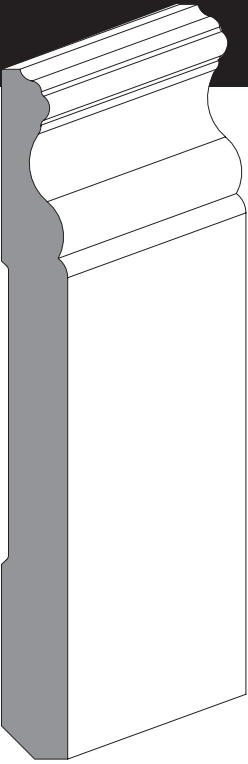

T2-106 11/16 x 7-1/4

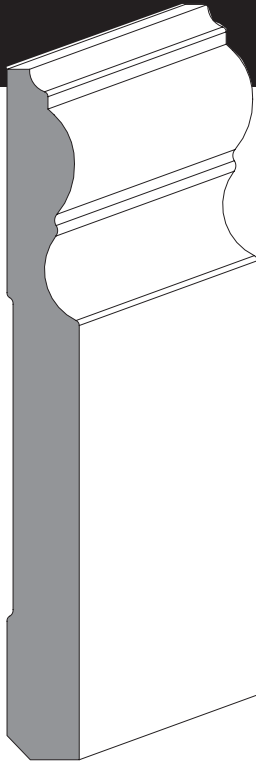

T2-108 11/16 x 7-1/4

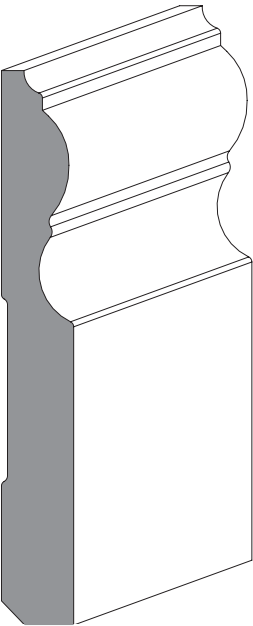

T2-119 11/16 x 5-1/2

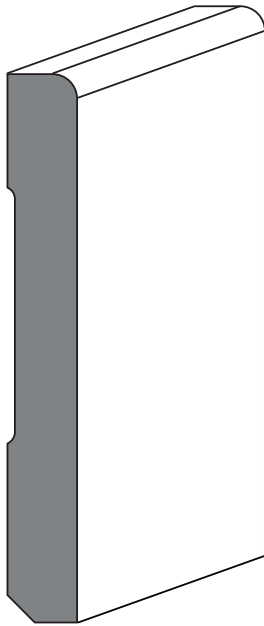

T2-118 11/16 x 5-1/2
(NEW)

BASEBOARDS

BASEBOARDS

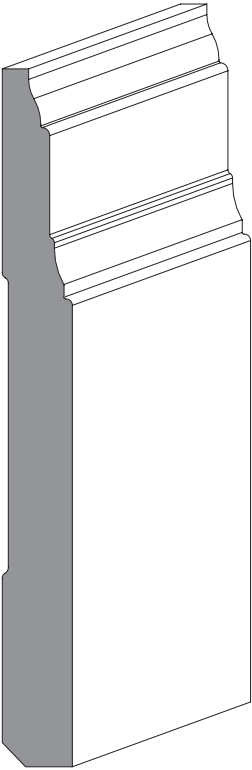

T2-109 11/16 x 7-1/4

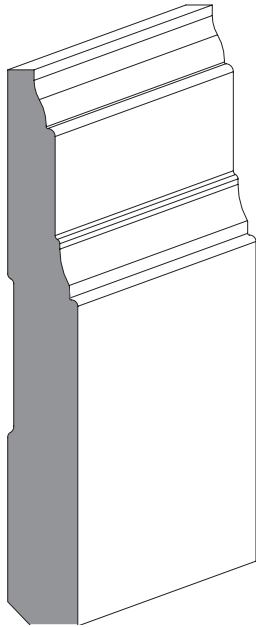

T2-119 11/16 x 5-1/2

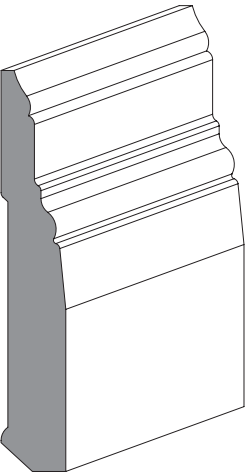

T2-111 11/16 x 4-1/4

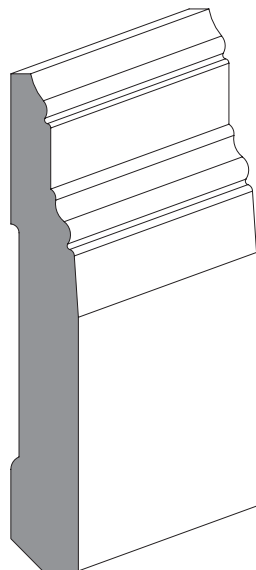

T2-112 11/16 x 5-1/4

BASEBOARDS

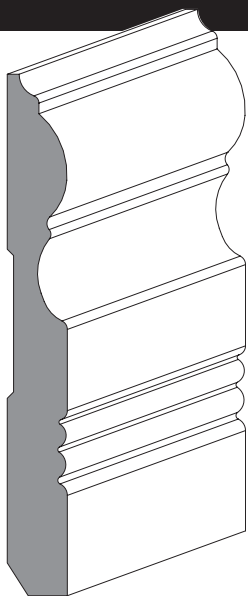

T2-121 11/16 x 5-1/2

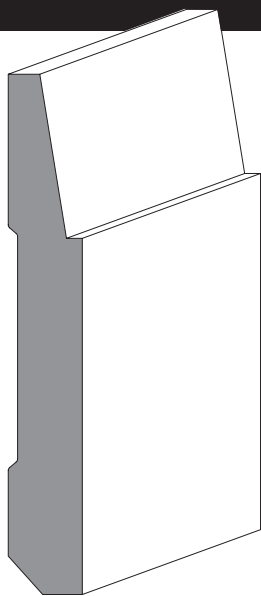

T2-131 11/16 x 5-1/2

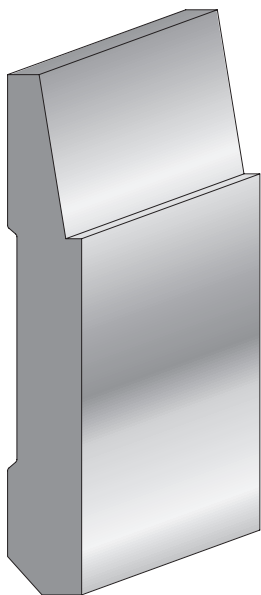

T2-231 5/8 x 5-1/4
Primed (NEW)

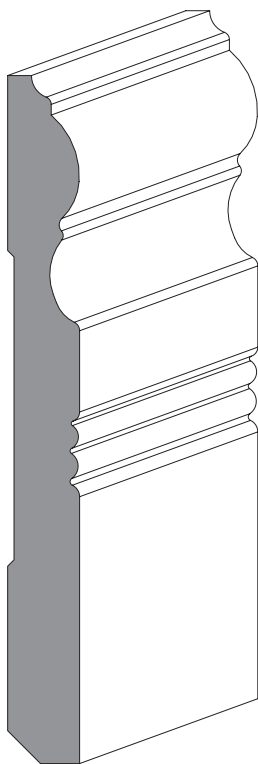

T2-122 11/16 x 7-1/4

BASEBOARDS

BASEBOARDS

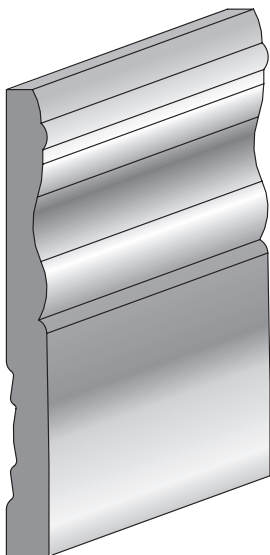

T2-141 3/8 x 4
Primed

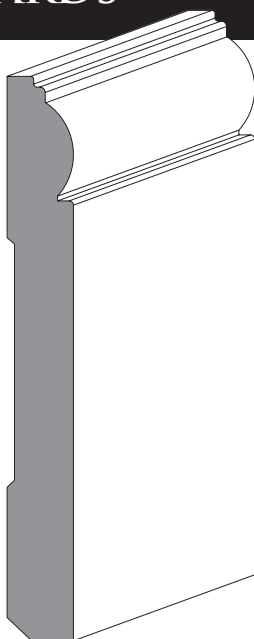

T2-016 11/16 x 5-7/8

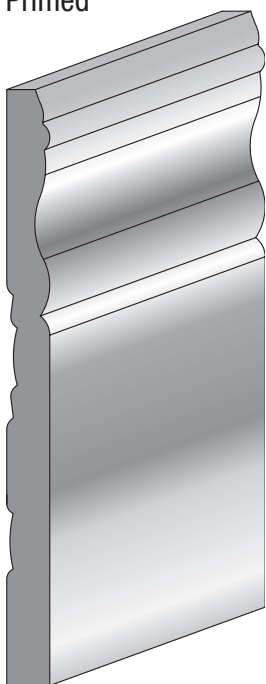

T2-142 7/16 x 5-3/16
Primed

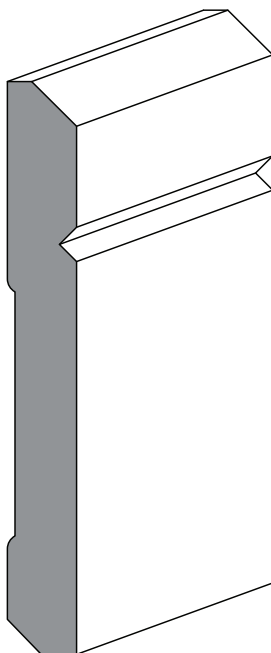

T2-001 11/16 x 5-1/2
(NEW)

CROWNS

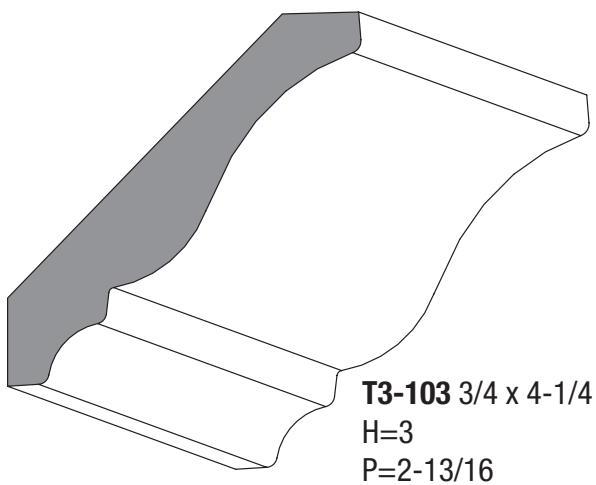
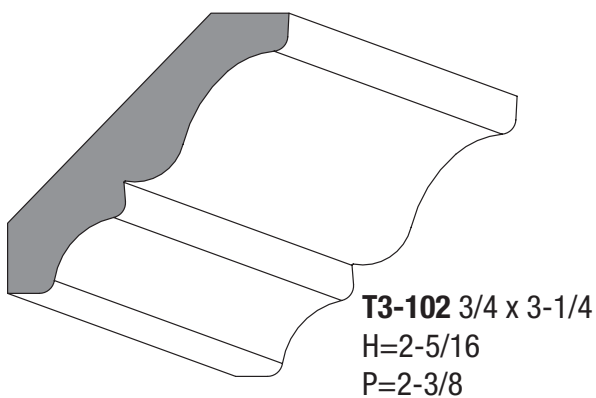
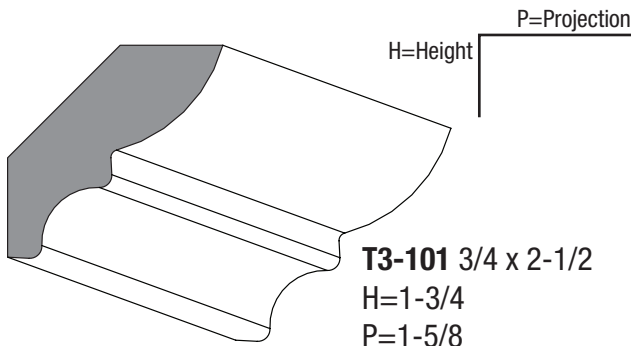

CROWNS

CROWNS

H=Height
P=Projection

T3-104
3/4 x 5-1/4
H=3-7/8
P=3-3/4

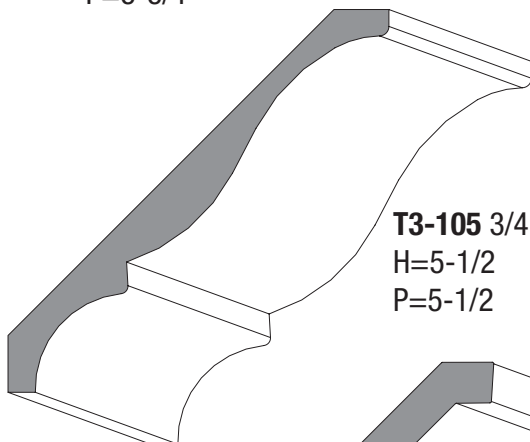

T3-105 3/4 x 7-1/4
H=5-1/2
P=5-1/2

T3-111 3/4 x 3-1/4
H=2-3/8
P=2-3/8

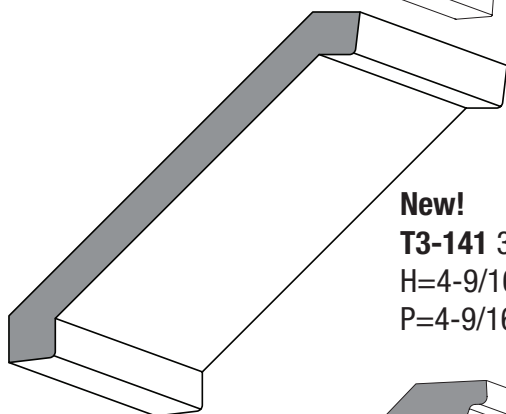

New!
T3-141 3/4 x 6-3/8
H=4-9/16
P=4-9/16

T3-116 3/4 x 4-1/2
H=3
P=3

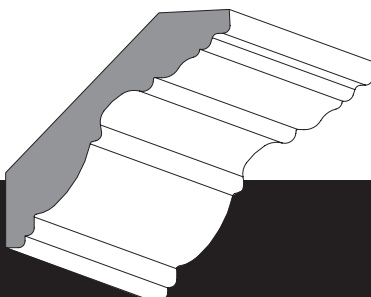

TWP Ltd.
Talbot Wood Products

CROWNS

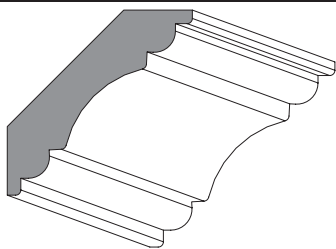

H=Height

P=Projection

T3-118 3/4 x 3-1/2
Symmetrical
H=2-3/8 P=2-3/8

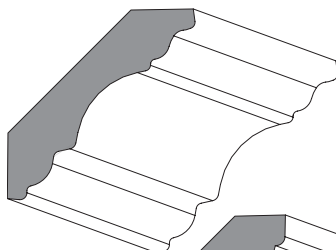

T3-122 3/4 x 3-1/2
H=2-3/8
P=2-3/8

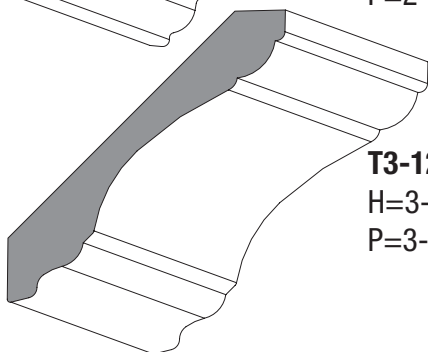

T3-123 3/4 x 5-1/4
H=3-3/4
P=3-3/4

T3-131 3/4 x 3-1/2
H=1-3/4
P=3-1/8

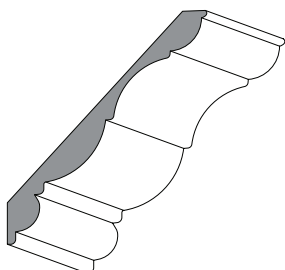
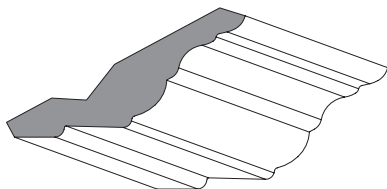

NEW!
T3-128 3/4 x 7-3/8
H=5-5/8
P=4-7/8

T3-142 3/4 x 4-5/8
H=3-9/16
P=2-7/8

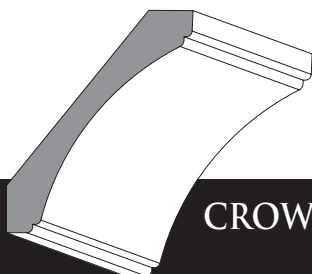

CROWNS

CROWNS

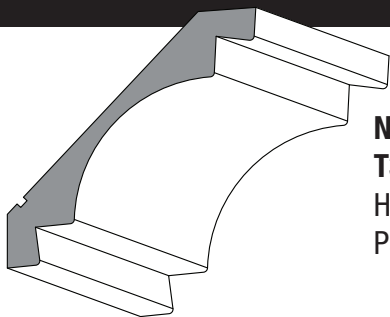

NEW!
T3-153 11/16 x 5
H=3-7/16
P=3-1/2

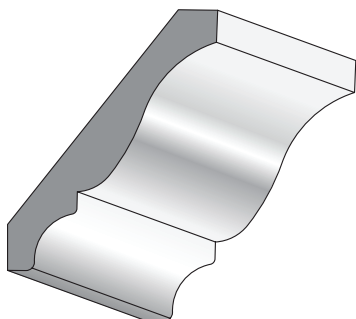

T3-135 11/16 x 4-1/2
Primed MDF
H=3-5/8
P=2-7/8

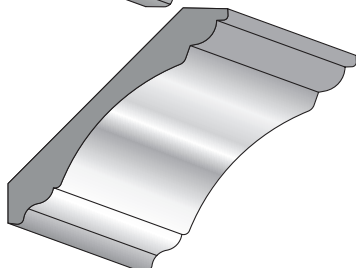

T3-136 5/8 x 4-1/2
Primed MDF
H=3-1/8
P=3-1/4

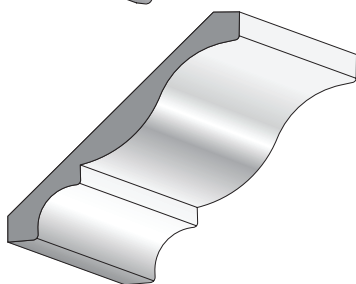

T3-137 5/8 x 5-1/2
Primed MDF
H=3-3/4
P=3-3/4

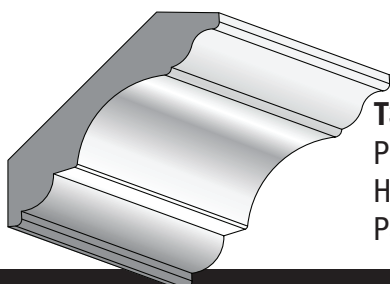

T3-157 9/16 x 3-5/16
Primed MDF
H=2-3/8
P=2-3/8

PANEL & APPLIED

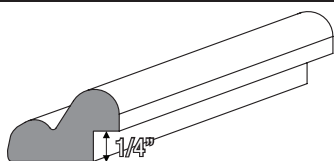

T4-101 5/8 x 1

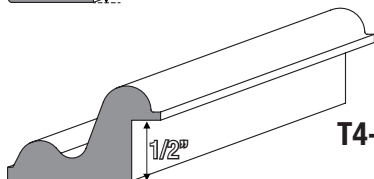

T4-102 13/16 x 1-3/8

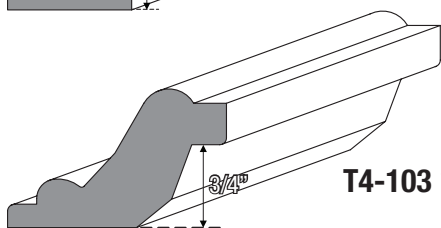

T4-103 1-15/16 x 1-1/8

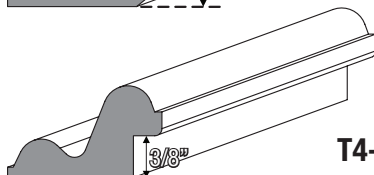

T4-104 13/16 x 1-3/8

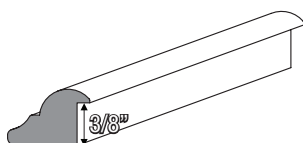

T4-105 1/2 x 3/4

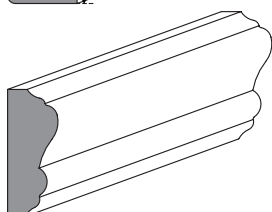

T4-111 7/16 x 1-1/8

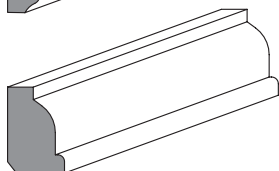

T4-112 1/2 x 3/4

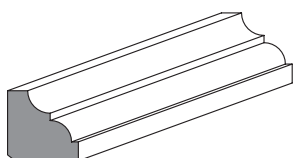

T4-113 5/8 x 5/8

PANEL & APPLIED

PANEL & APPLIED

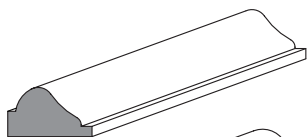

T4-116 7/16 x 3/4

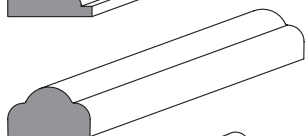

T4-121 7/16 x 3/4



T4-122 3/8 x 3/8

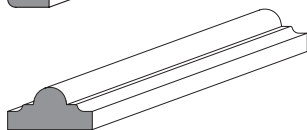

T4-123 3/8 x 3/4

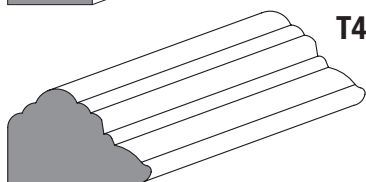

T4-124 13/16 x 1-1/4

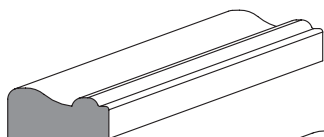

T4-125 7/16 x 7/8

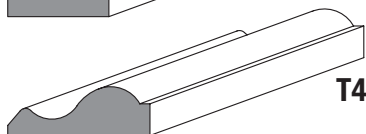

T4-126 7/16 x 1-1/8

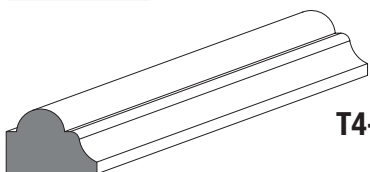

T4-128 5/8 x 1/2

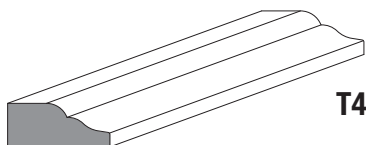

T4-131 3/4 x 5/16

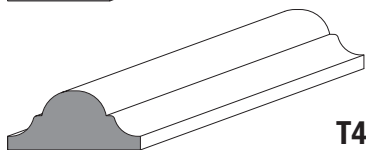

T4-132 1-1/8 x 1/2

QUARTER ROUNDS, BURLAP, COVES

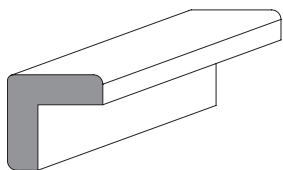

T4-201 1 x 1

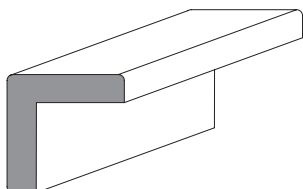

T4-202 1-1/4 x 1-1/4

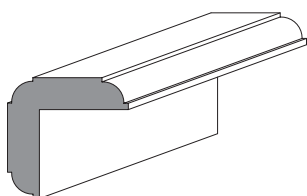

T4-203 1-1/4 x 1-1/4

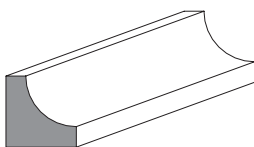

T4-211 3/4 x 3/4

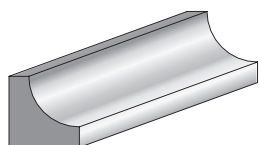

T4-214 11/16 x 11/16
Primed Finger Joint

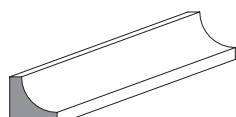

T4-212 1/2 x 1/2

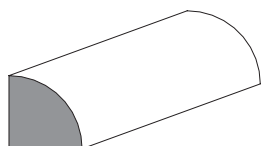

T4-221 3/4 x 3/4

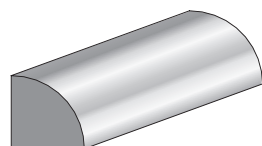

T4-205 11/16 x 11/16
Primed Finger Joint

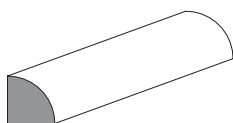

T4-222 1/2 x 1/2

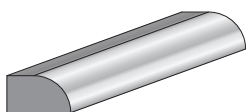

T4-230 13/16 x 3/8
Primed Finger Joint

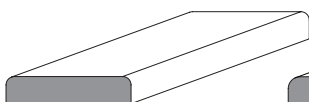

T4-231 5/16 x 1-1/4

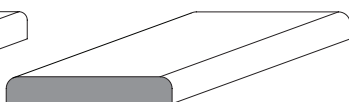

T4-232 5/16 x 1-3/4

QUARTER ROUNDS, BURLAP, COVES

BEDMOULDS, DOORSTOPS

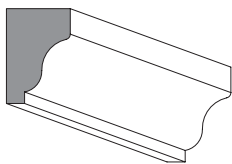

T4-301 3/4 x 1-1/8

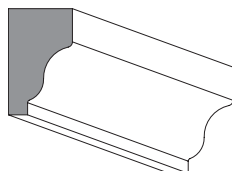

T4-302 3/4 x 1-1/4

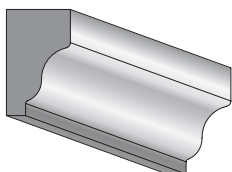

T4-302 3/4 x 1-1/4
Primed Finger Joint

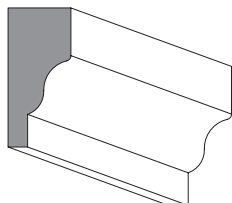

T4-303 3/4 x 1-5/8

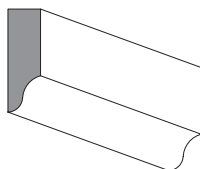

T4-322 3/8 x 1-1/4

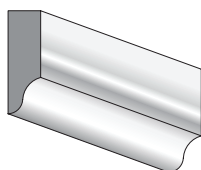

T4-307 7/16 x 1-3/16
Primed Finger Joint

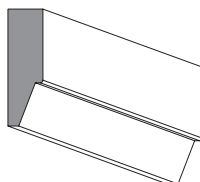

NEW!
T4-308 7/16 x 1-3/8

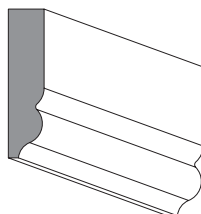

T4-309 7/16 x 1-3/4

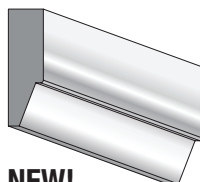

NEW!
T4-311 size
Primed Finger Joint

CHAIR RAILS

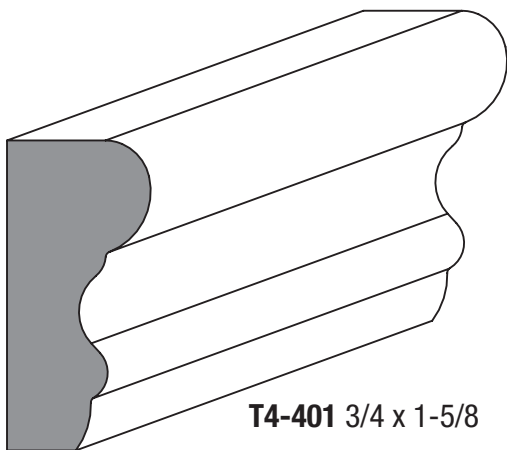

T4-401 3/4 x 1-5/8

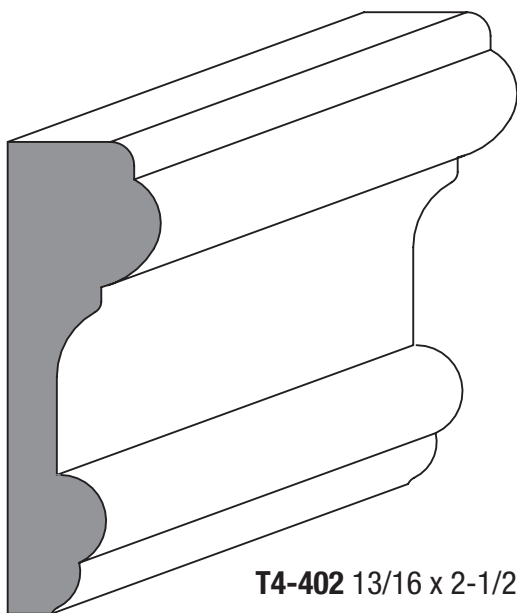

T4-402 13/16 x 2-1/2

CHAIR RAILS

BAR RAILS

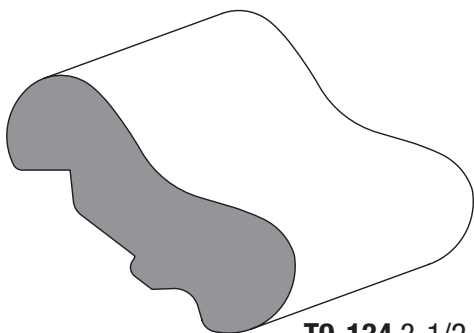

T9-134 3-1/2

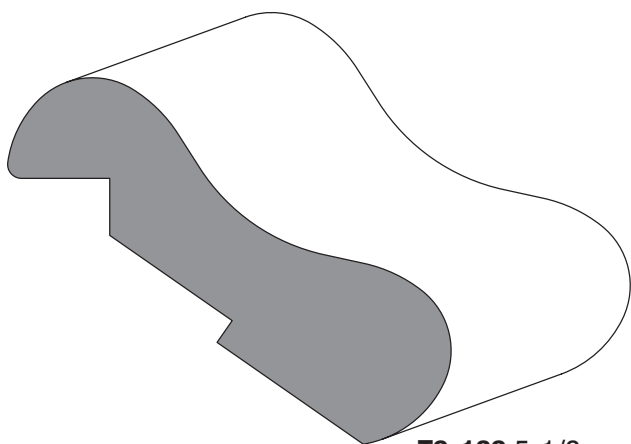

T9-139 5-1/2

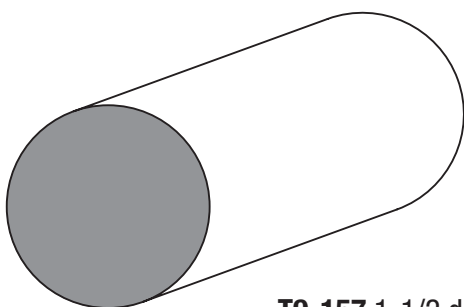

T9-157 1-1/2 diameter

HANDRAILS

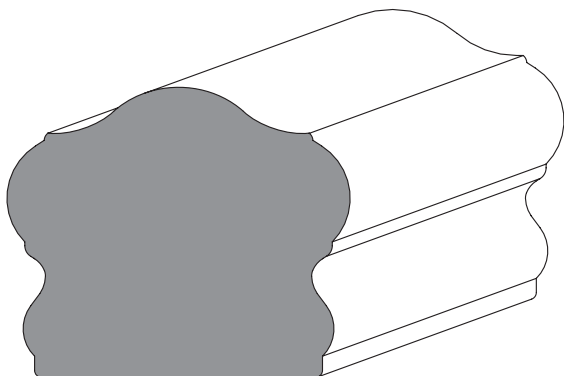

T5-110 2-9/16 x 3-1/8

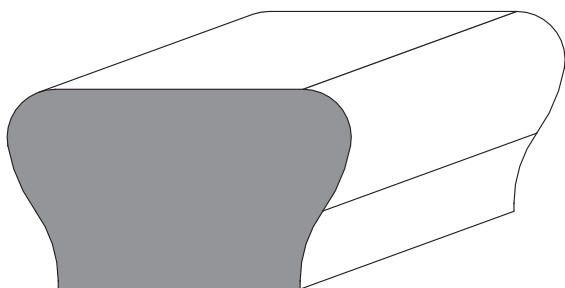

T5-120 1-3/4 x 3

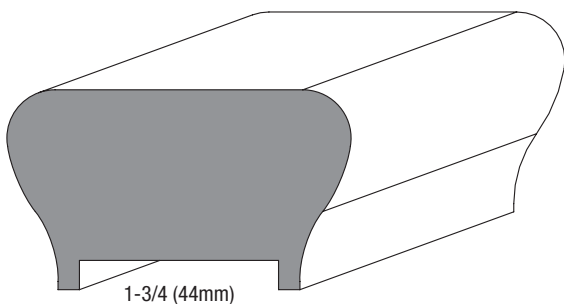

1-3/4 (44mm)

T5-122 1-3/4 x 3

HAND RAILS

HANDRAILS

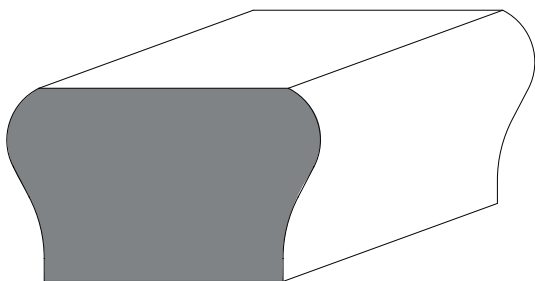

T5-130 1-3/4 x 2-3/4

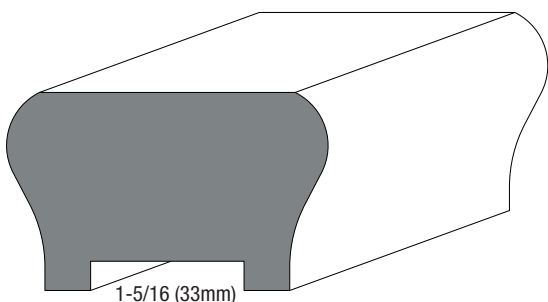

T5-131 1-3/4 x 2-3/4

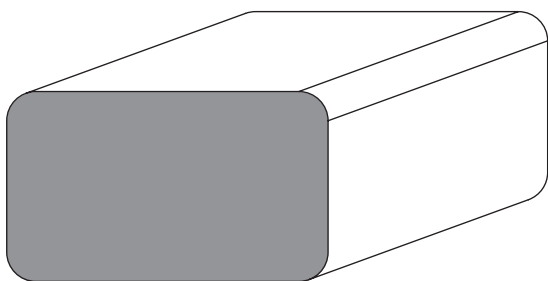

T5-135 1-5/8 x 2-3/4

SPINDLES



T5-232 48

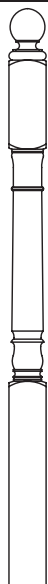

T5-231 52



T5-232 48

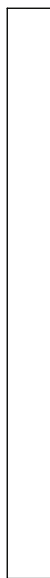

T5-231 52

All posts 3-1/2 x 3-1/2. Half posts available.

Spindles - 1-5/16 x 1-5/16 & 1-3/4 x 1-3/4.

T5-214 1-5/16 x 36

T5-211 1-5/16 x 36 Square

T5-212 1-5/16 x 38

T5-210 1-5/16 x 42

T5-215 1-5/16 x 42 Square

T5-224 1-3/4 x 36

T5-219 1-3/4 x 36 Square

T5-222 1-3/4 x 38

T5-220 1-3/4 x 42

T5-225 1-3/4 x 42 Square

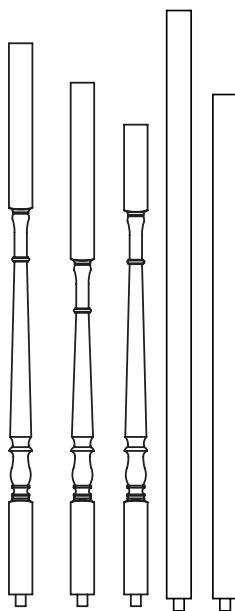

SPINDLES

CUSTOM POSTS & CAPS

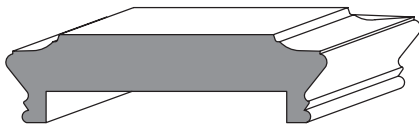
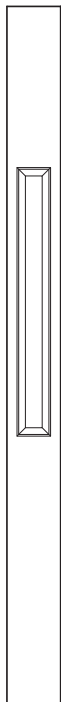

Decorative Posts - Maple/Oak:
4" x 4" x 52".

Custom Cap Stock Sizes
3-1/2" x 3-1/2" and 4" x 4". All other sizes require 2 to 3 week lead time.
Maple and Oak

STAIR TREADS

Stair treads are stocked in Maple and Oak
1-1/16" thick, 10-1/2" deep, 42" and 48" wide
with a bull nosed front edge.

Custom stair treads are made to order. Please
allow a 2 week lead time for custom treads.



10-1/2" deep x 42"

10-1/2" deep x 48"



1" stair tread with 1" return

TWP
Talbot Wood Products Ltd.

STAIR COMPONENTS

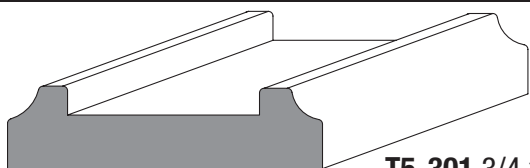

T5-301 3/4 x 2-7/8

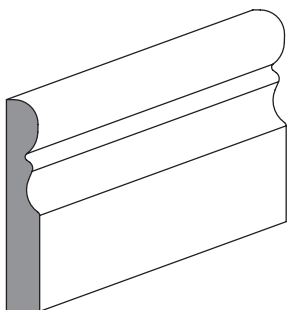

T5-302 1/4 x 1-5/8

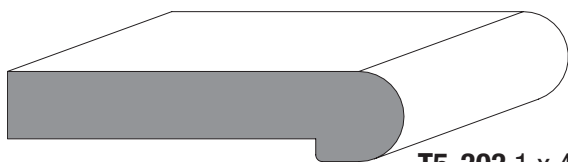

T5-303 1 x 4-1/2

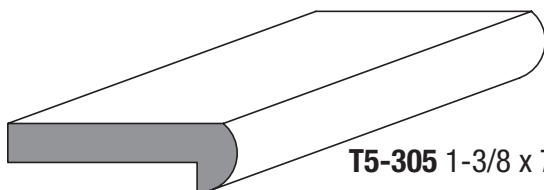

T5-305 1-3/8 x 7/16

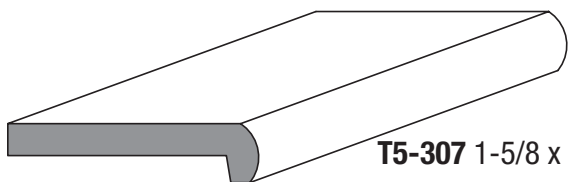

T5-307 1-5/8 x 7/16



T5-310 1 x 5-1/2

Bullnose

STAIR COMPONENTS

DRESSED FOUR SIDES

Talbot Wood stocks a wide variety of D4S material in Poplar, Oak, Maple and Cherry. Non stock items are produced weekly and to customer specifications.

Code	Nominal Size	Actual Size	In Stock/ Special Order
T8-101		1/2" x 3/4"	S/O
T8-102		1/2" x 3/4"	S/O
T8-103		3/4" x 3/4"	Stock
T8-104	1x2	3/4" x 1-1/2"	Stock
T8-105	1x3	3/4" x 1-1/2"	Stock
T8-106	1x4	3/4" x 3-1/2"	Stock
T8-107	1x5	3/4" x 4-1/2"	Stock
T8-108	1x6	3/4" x 5-1/2"	Stock
T8-110	1x8	3/4" x 7-1/4"	Stock
T8-111	1x10	3/4" x 9-1/4"	Stock
T8-112	1x12	3/4" x 11-1/4"	Stock
T8-120	2x2	1-5/8" x 1-5/8"	S/O
T8-121	2x3	1-5/8" x 2-1/2"	S/O
T8-122	2x4	1-5/8" x 3-1/2"	S/O
T8-123	2x5	1-5/8" x 4-1/2"	S/O
T8-124	2x6	1-5/8" x 5-1/2"	S/O
T8-126	2x8	1-5/8" x 7-1/4"	S/O
T8-127	2x10	1-5/8" x 9-1/4"	S/O
T8-128	2x12	1-5/8" x 11-1/4"	S/O



BEVELLED JAMBS



T7-204 3/4 X 4-5/8



T7-206 3/4 X 6-5/8



T7-208 11/16 X 4-5/8 X 7 Primed Finger Joint



NEW! T7-209 11/16 X 6-5/8 Primed Finger Joint

FLOORING & WAINSCOTTING

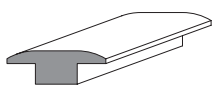

T9-114 1-3/4 x 5/8

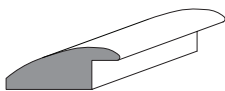

T9-115 2 x 3/4



T7-101 3/4 x 3-1/4

Note: Custom widths available: Square edge and micro-bevel

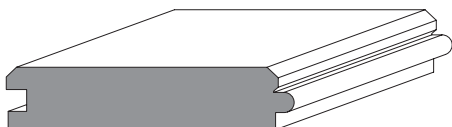

T7-111 1 x 4 VMATCH
(3/4 x 3-1/2)



T7-112 1 x 6 VMATCH
(3/4 x 5-1/4)



T7-114 1 x 6 T&G BEAD
(3/4 x 5-1/4)

SHIP LAP



T7-105 3/4 x 5-1/4



T7-107 3/4 x 7-1/4

LAMINATED PANELS

Talbot Wood offers laminated solid wood panels for a wide range of applications such as bench seating, bar tops, kitchen islands, stair treads and many other high use areas. Species, thickness, width and length are all made to customer specification. Laminated panels are made on a daily basis, allowing for the greatest flexibility and fast lead times.

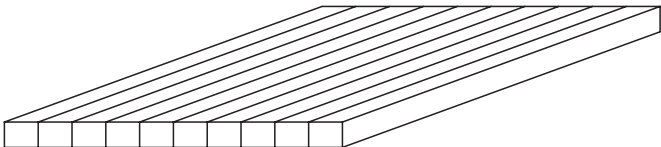

SHIP LAP/
LAMINATED PANELS

INTERIOR DOORS

Hollow Core Doors: Talbot Wood offers a large selection of both solid and hollow core doors. These doors are practical, economically priced and come in a wide variety of sizes and designs. Pre-hung doors are also available.

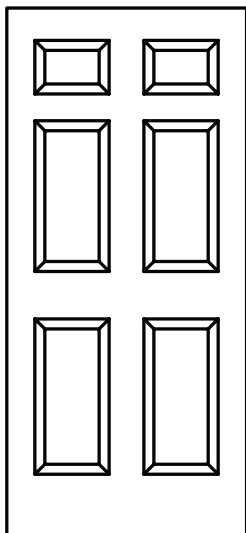

COLONIST

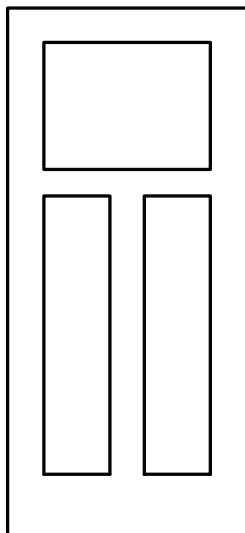

CRAFTSMAN

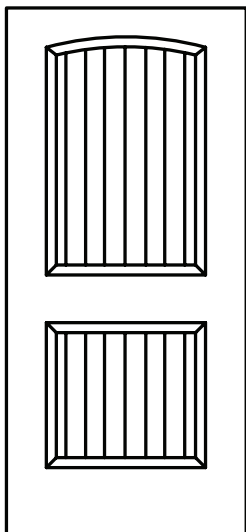

SANTA-FE

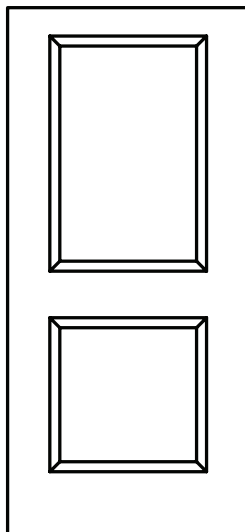

CAMBRIDGE

SHEET STOCK INVENTORY

Sheet Stock

Melamine

1/2" 4' x 8' White
5/8" 4' x 8' White
3/4" 4' x 8' White
1/2" 4' x 8' Merit Maple
5/8" 4' x 8' Merit Maple
3/4" 4' x 8' Merit Maple
1/2" 4' x 8' Almond
5/8" 4' x 8' Almond
3/4" 4' x 8' Almond
5/8" 4' x 8' Hardrock
3/4" 4' x 8' Hardrock

MDF

1/8" 4' x 8'
1/4" 4' x 8'
3/8" 4' x 8'
1/2" 4' x 8'
5/8" 4' x 8'
3/4" 4' x 8'
3/4" 4' x 8' G1S/
White Melamine
1" 4' x 8'
1-1/4" 4' x 8'

Red Oak

5.2mm 4' x 8' G2S PC
1/4" 4' x 8' G1S (Import) PC
1/2" 4' x 8' G1S VC
5/8" 4' x 8' G2S PC
5/8" 4' x 8' G1S/
White Melamine
3/4" 4' x 8' G2S VC

Maple

5.2mm 4' x 8' G1S VC
5.2mm 4' x 8' G2S PC
1/2" 4' x 8' G1S VC
5/8" 4' x 8' G2S PC
5/8" 4' x 8' G1S/
White Melamine
3/4" 4' x 8' G2S PC
3/4" 4' x 8' G2S VC

Cherry

5.2mm 4' x 8' G2S PC
3/4" 4' x 8' G2S VC

Birch

5.2mm 4' x 8' G2S PC
3/8" 4' x 8' G1S VC
1/4" 4' x 8' Pre-finished
1 side VC
1/2" 4' x 8' G2S VC
Pre-finished 2 sides
5/8" 4' x 8' G2S VC
Pre-finished 2 sides
3/4" 4' x 8' G2S VC
Pre-finished 2 sides
3/4" 4' x 8' C/2 VC
1/2" 4' x 8' C/2 VC
5.2mm 4' x 8' C/2 VC



POCKET CATALOGUE

TWP

Ltd.
Talbot Wood Products



Please be sure to check out our Door and
Drawer Catalogue for other products

Wood Doors



MDF Doors



Dovetail Drawers



5585 Hwy 3 • PO Box 190
Cayuga, ON N0A 1E0



talbotwood.com



P. 905.772.0007 • F. 905.772.6363
info@talbotwood.com